

Read First

PROP 65 WARNING

⚠ WARNING: Operating, servicing and maintaining a recreational marine vessel can expose you to chemicals including engine exhaust, carbon monoxide, phthalates, and lead, which are known to the State of California to cause cancer and birth defects or other reproductive harm. To minimize exposure, avoid breathing exhaust, service your vessel in a well-ventilated area and wear gloves or wash your hands frequently when servicing this vessel. For more information go to www.P65warnings.ca.gov/marine.

<https://www.p65warnings.ca.gov/products/recreational-vessels>: Requirement effective 8/30/2016

U.S. COAST GUARD GRANT OF EXEMPTION

THIS VESSEL IS MANUFACTURED BY KRASH LLC (WILMINGTON, DELAWARE). PER 46 U.S.C. § 4305 AND U.S. COAST GUARD GRANT OF EXEMPTION (21EX0128), THE COAST GUARD EXEMPTS THIS VESSEL FROM ONE OR MORE SAFETY REGULATIONS. 21EX0128 STATES THAT CERTAIN REGULATIONS ARE INAPPLICABLE IN LIGHT OF THIS VESSEL'S CHARACTERISTICS AND THAT THE EXEMPTION WILL NOT HAVE AN ADVERSE EFFECT ON RECREATIONAL BOATING SAFETY. THIS BOAT COMPLIES WITH U.S. COAST GUARD SAFETY STANDARDS IN EFFECT ON 20 APRIL 2022. ALL PERSONS SHOULD WEAR A LIFEJACKET (PERSONAL FLOTATION DEVICE) WHILE OPERATING OR RIDING ON THIS WATERCRAFT.

READ THIS FIRST

WARNING

DO NOT consume alcohol or drugs before or during operation of a personal watercraft.

Always wear a U.S.C.G. approved personal flotation device suitable for use while riding a personal watercraft.

Users outside the US may have their own requirements; be sure to follow them. Contact your local maritime safety authority for up to date information.

Always wear suitable protective clothing while riding a personal watercraft. Severe internal injuries can occur if water is forced into body cavities as a result of falling into water or being near jet thrust nozzle. Normal swimwear does not adequately protect against forceful water entry into the rectum or vagina. All riders must wear a wetsuit bottom or clothing that provides equivalent protection. Footwear, gloves and eyewear are recommended.

A boater safety course is highly recommended, and may be required in your state or country.

The inherent nature of operating a personal watercraft requires the operator is in good health and able to swim competently. Do not ride farther from shore than the operator can swim back.

DO NOT apply throttle when anyone is near the rear of the watercraft. Water and debris exiting the jet pump can cause severe injury.

DO NOT reach into the intake grate, steering nozzle or exhaust when the watercraft is running, or could be started. Severe injury will occur.

★ [IMG1010: PICTURE OF INTAKE GRATE & STEERING NOZZLE WITH ARM REACHING IN WITH RED X]

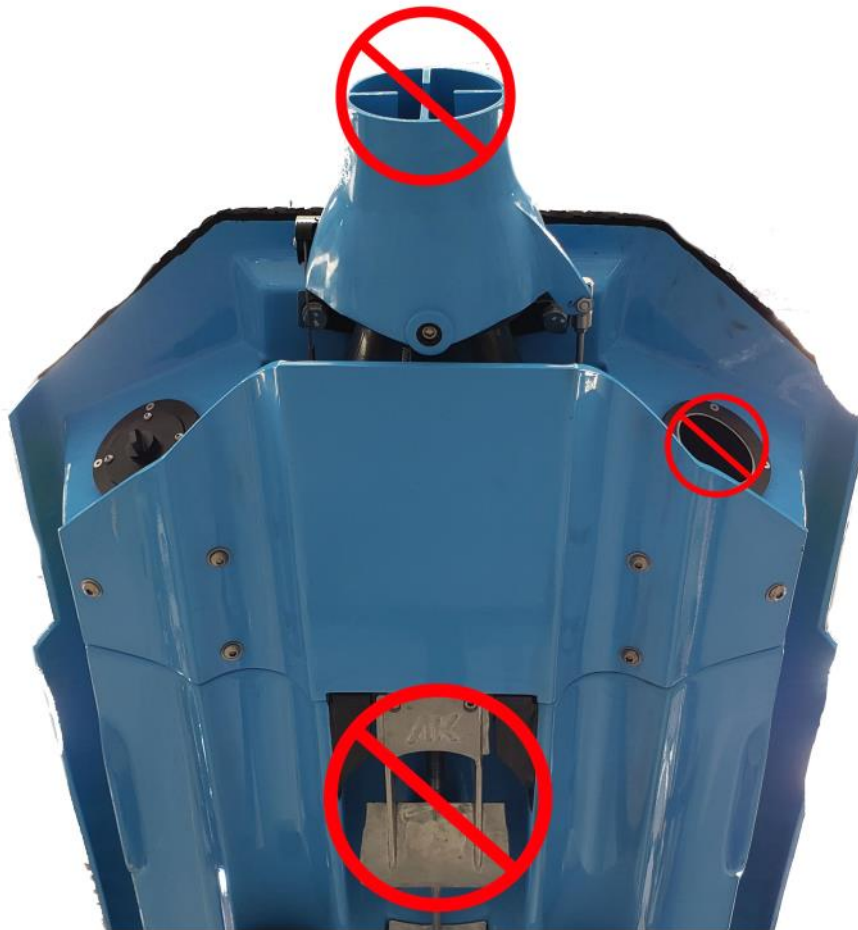

Keep the intake grate clear of items such as clothing, long hair and PFD straps which could be sucked into the jet pump causing injury or drowning.

This is a high-performance personal watercraft intended for use by persons 16 years of age or older.

The operating capacity of 1 rider, the operator, should never be exceeded.

This watercraft is not equipped with a brake.

DO NOT release the throttle or stop the engine when trying to steer away from hazards. You need throttle to steer.

Always ensure the engine shut-off safety lanyard is attached to the operator prior to launching.

Always disconnect the battery when performing maintenance on the watercraft. Disconnect negative (-) first, positive (+) second.

This watercraft will not right itself if capsized. DO NOT reach into intake grate or steering nozzle. Remove safety lanyard from engine shut-off switch immediately. You must follow the proper procedure (see "RIGHTING CAPSIZED WATERCRAFT" on page XX) to right the craft as soon as possible.

DO NOT rotate capsized watercraft in a counter-clockwise direction. Only rotate clockwise as shown below. Serious engine damage could result.

★ [IMG1020: RIGHTING DIRECTION OF ROTATION FROM REAR OF HULL WITH OPERATOR IN WATER]

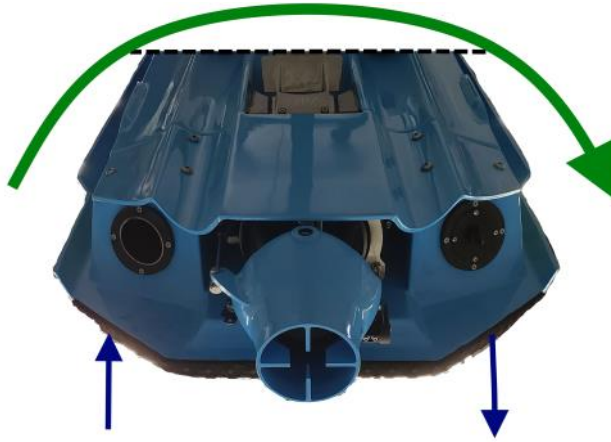

If the watercraft was capsized for an extended period of time, began to sink, or did sink, water could have entered the engine. **DO NOT** start the engine. You must follow the procedure for removing water from the engine first (see "SUBMERGED WATERCRAFT on page XX). Serious engine damage will occur.

DO NOT operate the watercraft in shallow water less than 2ft in depth (approximately knee height).

Know and understand all applicable boating laws. Boater safety and training courses are recommended for all operators. Respect the environment and those you occupy the water with. Operating a personal watercraft is a privilege that comes with responsibility.

Specifications

Friday, 18 November 2022 3:48 PM

ENGINE

Type	2-stroke, Inline vertical twin
Displacement	1,162cm ³ [70.9 cu in.]
Bore x Stroke	95 x 82mm [3.74 x 3.22in.]
Number of Cylinders	2
Compression Ratio	12.2 : 1
Spark Plug	NGK BPR8ES - Electrode Gap 0.7-0.8mm [0.027-0.032in]
Cylinder Compression	1,137kPa [165psi]
Intake System	Reed Valve, Ø48mm Throttle Bodies
Fuel Delivery	Dual Port Fuel Injection
Ignition System	Smart Coil
Lubrication System	Oil Injection
Starter System	Electric Stater Motor
Cooling System	Water, Open Loop
Idle RPM	2200 ± 100 RPM in water 2600 ± 100 RPM out of water
Battery Type	Sealed AGM (Absorbed Glass Mat)
Battery Voltage	12 V
Battery Capacity	21 Ah, 310 CCA
Charging System	Alternator + Regulator/Rectifier

DRIVE SYSTEM

Propulsion	Jet Pump
Coupling	Direct Drive
Jet Pump	Axial Flow, Single Stage
Rotation	Counter-Clockwise
Pump Diameter	148mm [5.82in]
Impeller Blades	3
Impeller Pitch	15°/22°
Trim System	0° to +22° [Footrocket, Footrocket Pro, Reaper] 0° to -10° [Pred-RR]
Steering	Steerable Nozzle
Braking	None, Water Drag

FUEL & OIL

Fuel Type	Unleaded, non-Ethanol.
Octane	93 min. Anti-Knock Index (AKI) or (R+M)/2 Method 98 min. RON
Fuel Tank Capacity	17.0 L [4.5 gal]

Fuel Pump Pressure	400 kPa [58psi]
Oil Tank Capacity	1.1 L [0.3 gal]
Oil Type	MOTUL 710 2T
Oil Delivery	Electronically controlled injection, direct to Crank Case.
Fire Extinguisher	First Alert FE5R-PWCNA

DIMENSIONS (L x W x H) & WEIGHT (DRY?)

Footrocket	2082 x 775 x 660mm [82 x 30.5 x 26in] 158kg [348lbs]
Footrocket Pro	2082 x 775 x 660mm [82 x 30.5 x 26in] 144kg [318lbs]
Pred-RR	2333 x 735 x 670mm [92 x 29 x 26.5in] 170kg [375lbs]
Reaper	2235 x 833 x 965mm [88 x 32.8 x 38in] 166kg [365lbs]

General Information

Friday, 18 November 2022 3:48 PM

Safety Warnings

This owner's manual contains the following warnings and cautions to indicate and inform the user of potential hazards

- **WARNING**
Indicates a potential hazard which, if not avoided, could result in severe injury or death.

- **CAUTION**
Indicates a potential hazard which could result in severe damage to equipment. Equipment damage could cause injury to rider.

Identification Numbers

Your craft is labelled with two unique sets of numbers you will use to register and, in the event it's stolen, identify it. Record and save these numbers in a safe place.

- ★ [IMG3010: HIN LOCATION, FOOTROCKET, PRED-RR, REAPER - BIGGER CALLOUT]
Footrocket & Footrocket Pro HIN Plate:

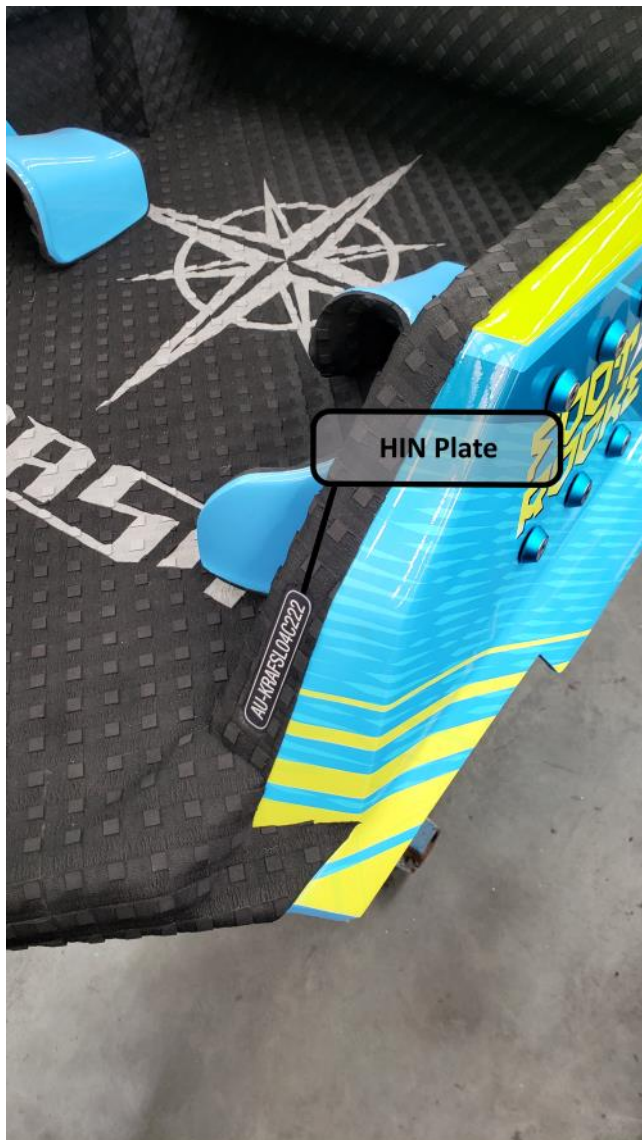

Pred-RR HIN Plate:





Reaper HIN Plate:





★ [IMG3020: ENGINE ID PLATE IN SKI - BIGGER CALLOUT]
Engine ID Plate:

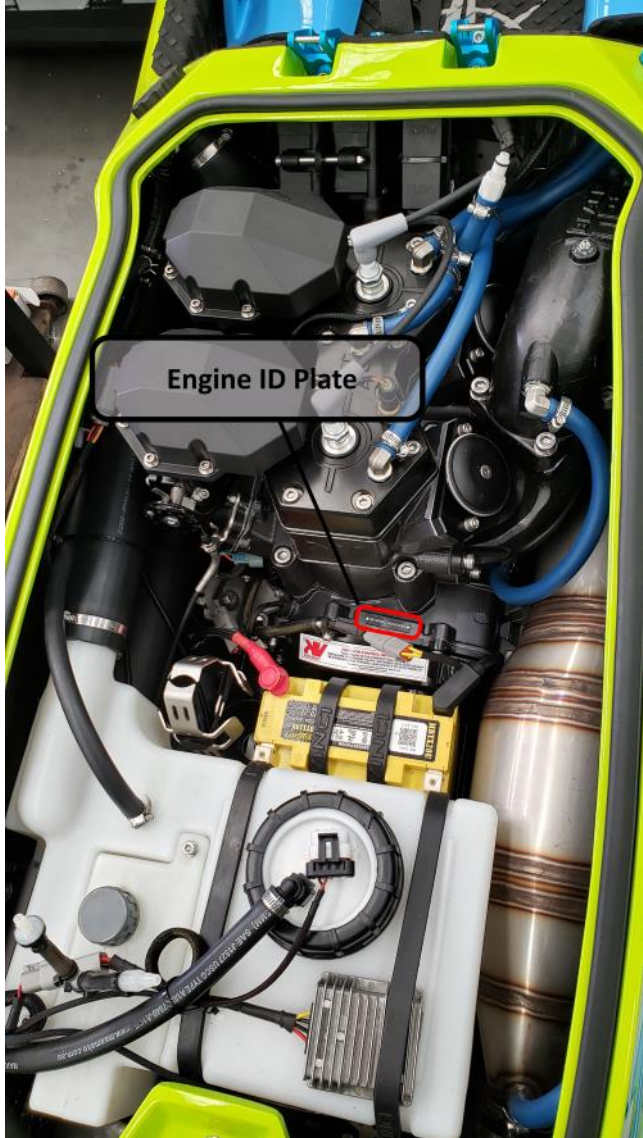

Important Labels

The following labels are on your Krash watercraft. They contain important general and safety information. Please read and understand them thoroughly. If you have any questions contact your dealer or Krash Industries directly. If any labels are damaged, worn, or missing replacements are available through your dealer.

- ★ [IMG3030: FULL SIZE COPY OF EACH STICKER - READABLE]
1. Safety Warning Sticker



⚠ WARNING

To reduce the risk of SEVERE INJURY or DEATH:
WEAR A PERSONAL FLOATATION DEVICE (PFD). All riders must wear a Coast Guard approved PFD that is suitable for personal watercraft (PWC) use.
WEAR PROTECTIVE CLOTHING. Severe internal injuries can occur if water is forced into body cavities as a result of falling into water or being near jet thrust nozzle. Normal swimwear does not adequately protect against forceful water entry into the rectum or vagina. All riders must wear a wetsuit bottom or clothing that provides equivalent protection. Footwear and gloves are recommended.
KNOW BOATING LAWS. Krash Industries recommends a minimum operator age of 16 years old. Know the operating age and training requirements for your state. A boating safety course is recommended and may be required in your state.
ATTACH ENGINE SHUT - OFF CORD (LANYARD) to wrist and keep it free from handlebars so that the engine stops if the operator falls off. After riding, remove cord from PWC to avoid unauthorised use by children and others.

2. Reboarding Warning Sticker

⚠ WARNING

AVOID SERIOUS INJURY OR DEATH:

- Engine must be turned off before re-boarding
- Keep away from propulsion system and intake grate.

WHEN RE-BOARDING

- Keep craft upright and stay centred to keep balance

3. Battery Voltage Sticker

⚠ WARNING

AVOID SERIOUS INJURY OR DEATH:
BATTERY:

- **DO NOT** use lithium batteries
- **ALWAYS** keep the battery charged at 12.6 volts

4. Fuel Warning Sticker

⚠ WARNING

Gasoline/Petrol is highly flammable and explosive. A fire or explosion could cause severe injury or death. Shut engine off. Refuel in a well-ventilated area away from flames or sparks. Do not smoke. Avoid spilling Gasoline/Petrol. Wipe up spilled Gasoline/Petrol immediately. Open hood to ventilate fuel vapours from engine compartment before starting engine. Do not start engine if there is a fuel leak or a loose electrical connection.

PREMIUM UNLEADED RECOMMENDED

5. Age, Alcohol & Drugs Warning Sticker

⚠ WARNING



Operating this PWC if you are under the age of 16 increases your chance of severe injury or death.



NEVER operate this PWC under the influence of alcohol. It may increase your chance of severe injury or death.



NEVER operate this PWC under the influence of drugs. It may increase your chance of severe injury or death.

6. Competition Use Only Sticker



CLOSED- COURSE COMPETITION USE ONLY

This water craft does not meet emissions standards for recreational use.

7. Rider Capacity Information Sticker



- ★ [IMG3040: EMISSIONS INFO STICKER - READABLE]
Emissions Information Sticker:



- ★ [IMG3050-1: HOOD STICKERS LOCATIONS FOR FOOTROCKET, PRED-RR]
Footrocket, Footrocket Pro & Pred-RR Sticker Locations:



1. Safety Warning Sticker
2. Reboarding Warning Sticker
3. Battery Voltage Sticker
4. Fuel Warning Sticker
5. Age, Alcohol & Drugs Warning Sticker

- 6. Competition Use Only Sticker
- 7. Rider Capacity Information Sticker

★ [IMG3050-2/3: HOOD STICKERS LOCATIONS FOR REAPER]
 Reaper Sticker Locations:

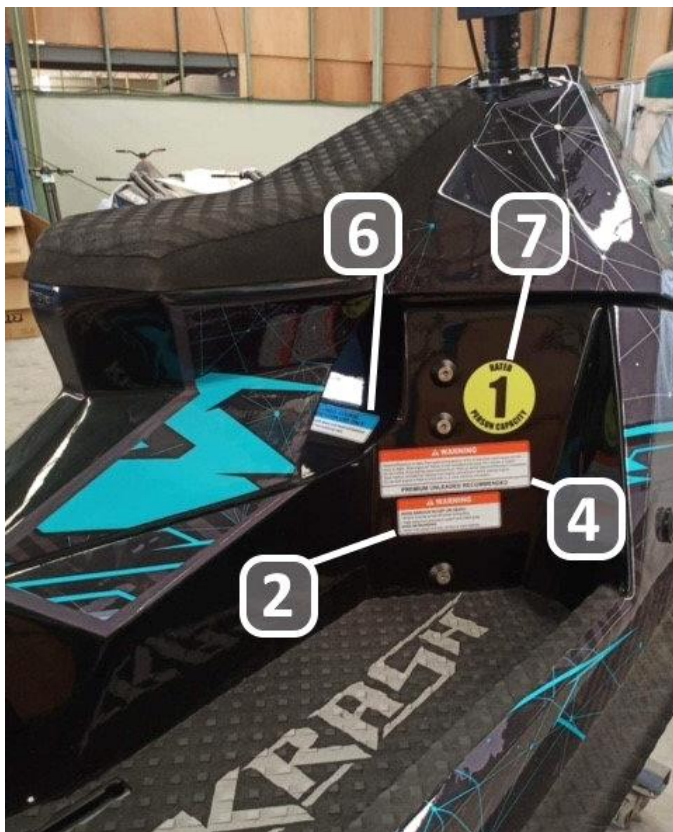

- 1. Safety Warning Sticker
- 2. Reboarding Warning Sticker
- 3. Battery Voltage Sticker
- 4. Fuel Warning Sticker
- 5. Age, Alcohol & Drugs Warning Sticker
- 6. Competition Use Only Sticker

7. Rider Capacity Information Sticker

- ★ [IMG3060: EMISSIONS INFO STICKER LOCATION]
Emissions Information Sticker:



Part Location / Identification

- ★ [IMG3070: SIDE ON VIEW]



1. STEERING
2. HANDLEBARS
3. HANDLE POLE
4. HOOD
5. BILGE PUMP OUTLET
6. EXTERNAL FILLER

★ [IMG3080: UNDERSIDE VIEW]

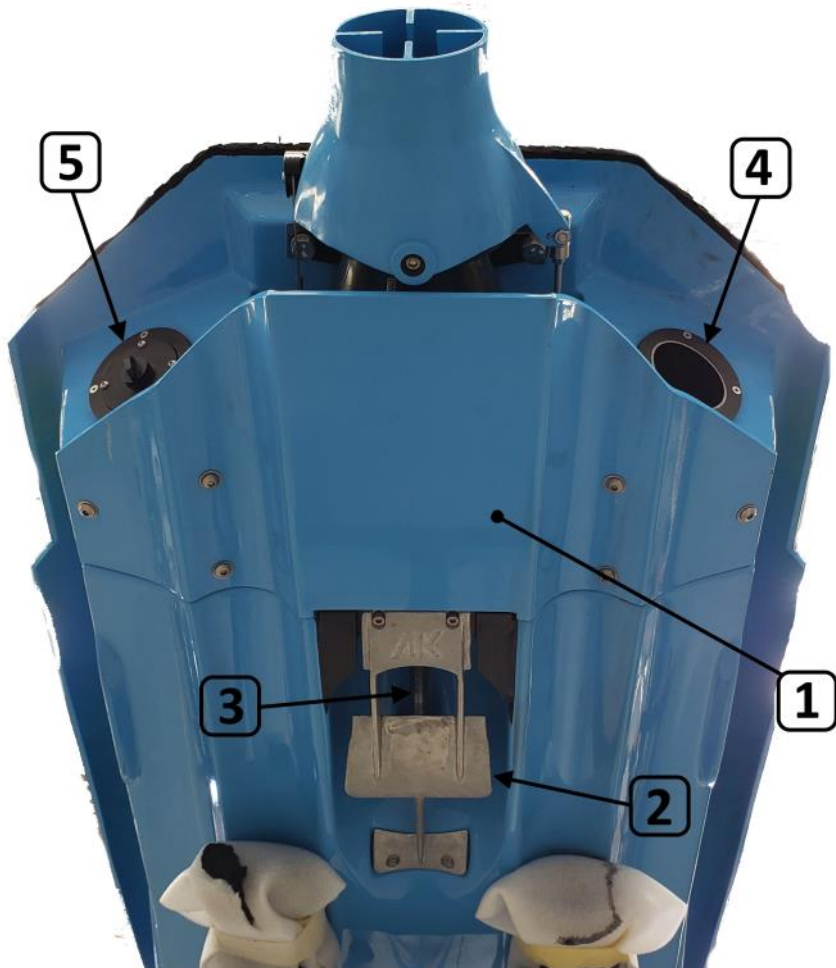

1. Ride Plate
2. Intake Grate
3. Drive Shaft
4. Exhaust Outlet
5. Scupper

★ [IMG3090: REAR VIEW]

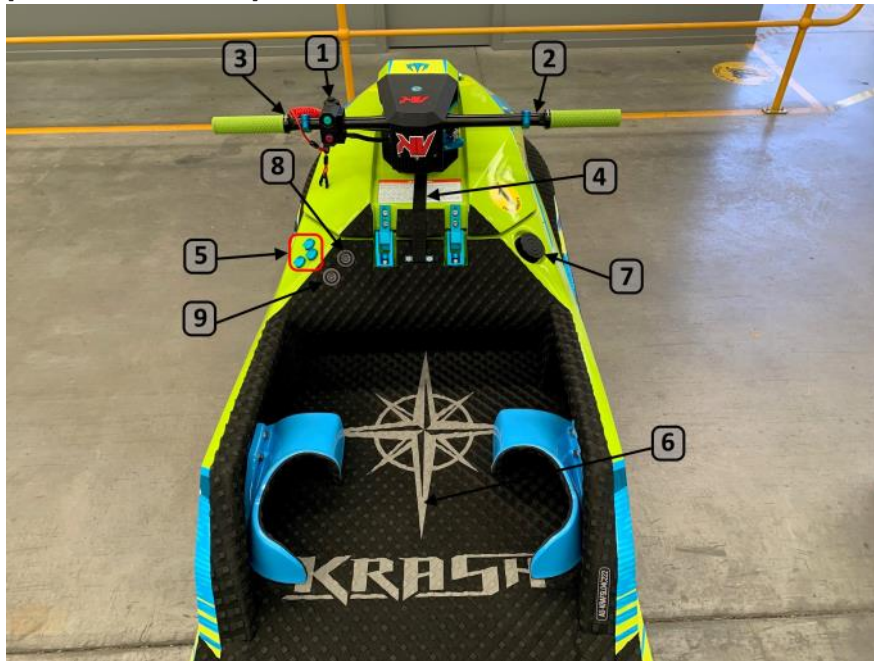

1. Start Stop Switch
2. Throttle Lever
3. Trim Lever
4. Hood Strap
5. Bypass Water Cooling Outlets
6. Foot Tray
7. External Filler
8. Ignition Button
9. Bilge Button

★ [IMG3100: ENGINE BAY VIEW]

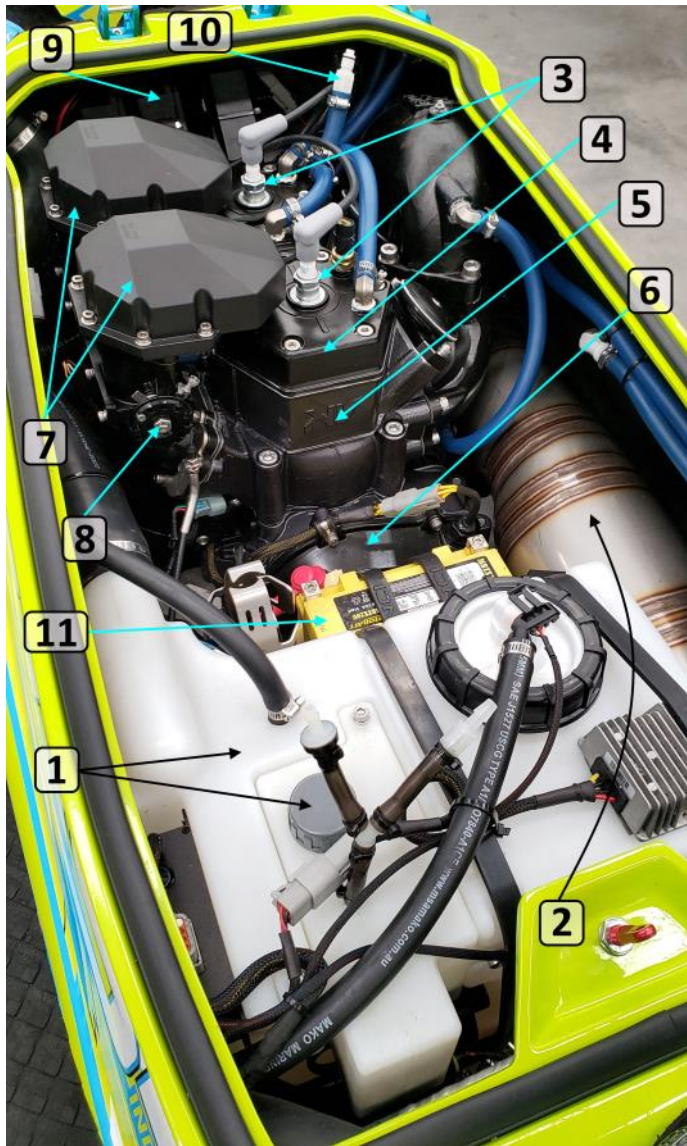

1. Fuel Tank & Oil Tank
2. Exhaust System
3. Spark Plugs
4. Cylinder Head
5. Cylinder
6. Flywheel Cover
7. Airbox Covers
8. Throttle Bodies
9. Electrical Bar
10. Flush kit
11. Battery

★ [IMG3110: E-BAR LOCATION]

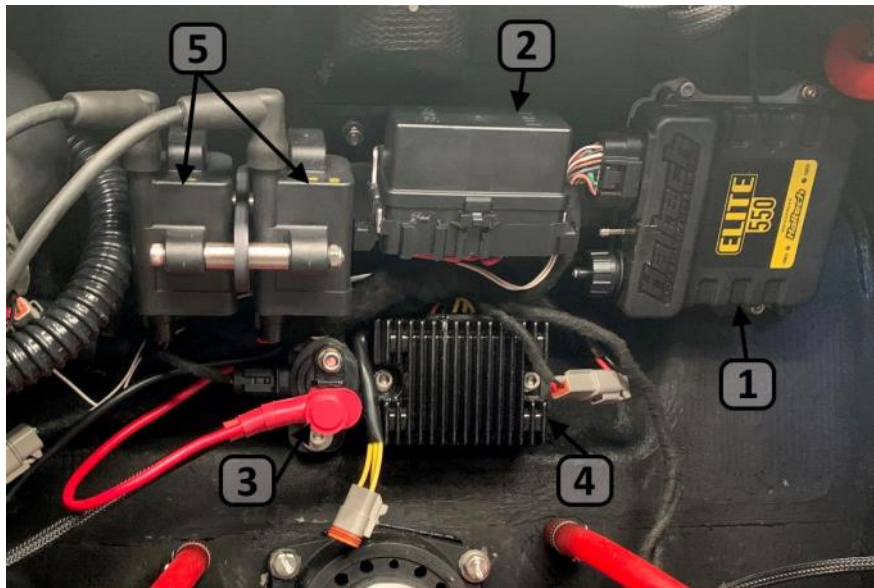

1. Microsquirt ECU / Haltech ECU (Pictured)
2. Fuse Box
3. Starter Relay
4. Regulator
5. Ignition Coils

★ [IMG3120: FUEL AND OIL TANK]

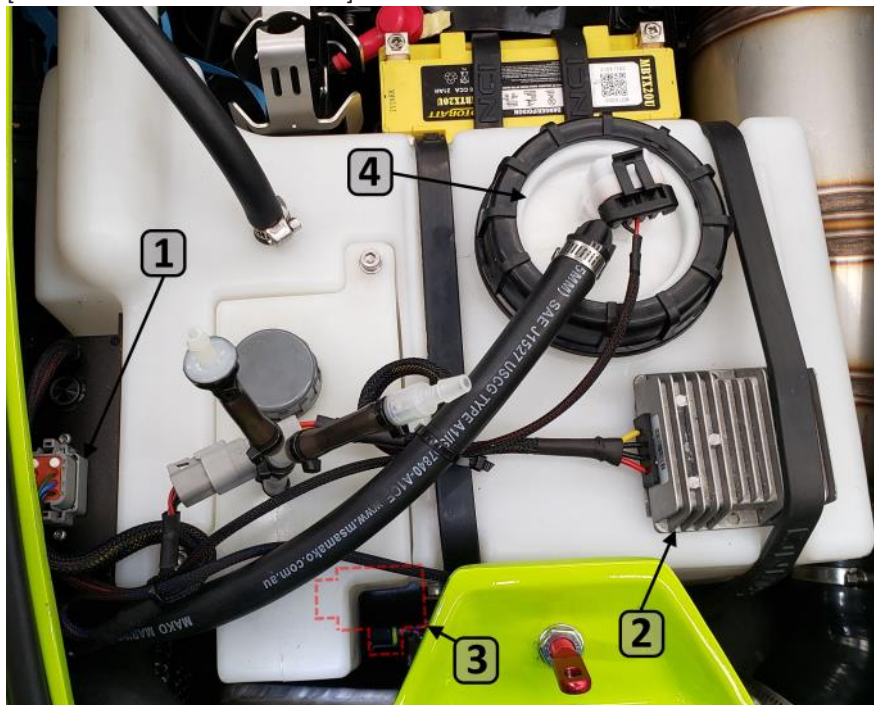

1. Oil pump controller
2. DC-DC Converter
3. Oil Pump (out of view)
4. Fuel Pump

Fuel & Oil

WARNING

Fuel and fuel vapours are extremely flammable and can be explosive. DO NOT smoke around fuel systems. Always remove safety lanyard from start stop switch, check the area is well ventilated and the area is free from sources of flames or sparks, before working with fuel or fuel systems.

Your Krash watercraft is equipped with our KV1162 Port Fuel Injection 2-stroke engine which requires premium fuel, and a premium 2-stroke oil. The watercraft has one tank for fuel and one tank for oil.

CAUTION

DO NOT USE leaded fuel, av-gas or octane boosting additives in place of recommended premium pump fuel. Engine and fuel system damage may occur, which Krash Industries is not responsible for.

The watercraft is equipped with an electronically controlled oil pump, which automatically injects oil directly into the crank case to lubricate the engine. The oil pump controller mounted to the fuel tank can be used to prime (purge of air) the oil lines after maintenance or servicing. See "Priming" on page XX for more information

CAUTION

Operating the watercraft with air in the oil lines can delay the oil reaching the engine and can cause engine damage. Always check oil tank level and that the oil lines are primed on first start-up, after servicing and maintenance, or if the oil tank level dropped below the minimum level.

FUEL TYPE

Use fresh, clean premium pump fuel with a minimum Anti-Knock Index (AKI) rating of 93, or a minimum Research Octane Number (RON) of 98.

The Anti-Knock Index is often written as $(RON + MON)/2$ or $(R+M)/2$. Octane rating, AKI, RON and $(R+M)/2$ are all measures of a gasoline's resistance to detonation or "knocking" which can cause serious engine damage.

Do not use oxygenated fuels such as ethanol blended (E10, E15, E85) and methanol blended fuels.

CAUTION

DO NOT USE fuel with an octane rating of lower than 91 AKI / 93 RON. Serious engine damage may occur, which Krash Industries is not responsible for.

OIL TYPE

Use a specific break in or mineral oil with your first two tanks of fuel while following proper break in procedure. Proper break in is essential. After break in is completed Krash recommends using a 100% synthetic, high performance 2-stroke engine lubricant, suitable for oil injection systems. If you are unable to purchase the recommended lubricant, contact your dealer.

CAUTION

DO NOT USE oil additives or oils that are not specifically designed for oil injection, or oil that does not meet the JASO FD and ISO-L-EDG standards. Engine damage may occur, which Krash Industries is not responsible for.

FILLING FUEL TANK

WARNING

DO NOT smoke around fuel systems. Remove safety lanyard from start switch before refuelling. Never refuel while engine is running or watercraft is floating in the water. Bring craft ashore, place on a trailer or on a stand onshore. Refuel your watercraft in a dry, well ventilated area. Do not overfill. Avoid refuelling during inclement weather to prevent fuel contamination. Thoroughly clean any excess or spilled fuel before starting engine.

Footrocket, Footrocket Pro & Pred-RR:

These models are fitted with an external fuel filler system. To fill the fuel tank, remove the filler cap, slowly add fuel until the fuel level is 12mm (1/2") from the top of the tank, taking care to not overfill. Reinstall the filler cap securely.

[IMG3130: SECTION VIEW OF STANDUP FILLER HOSE AND TANK TO INDICATE MAX FUEL LEVEL]

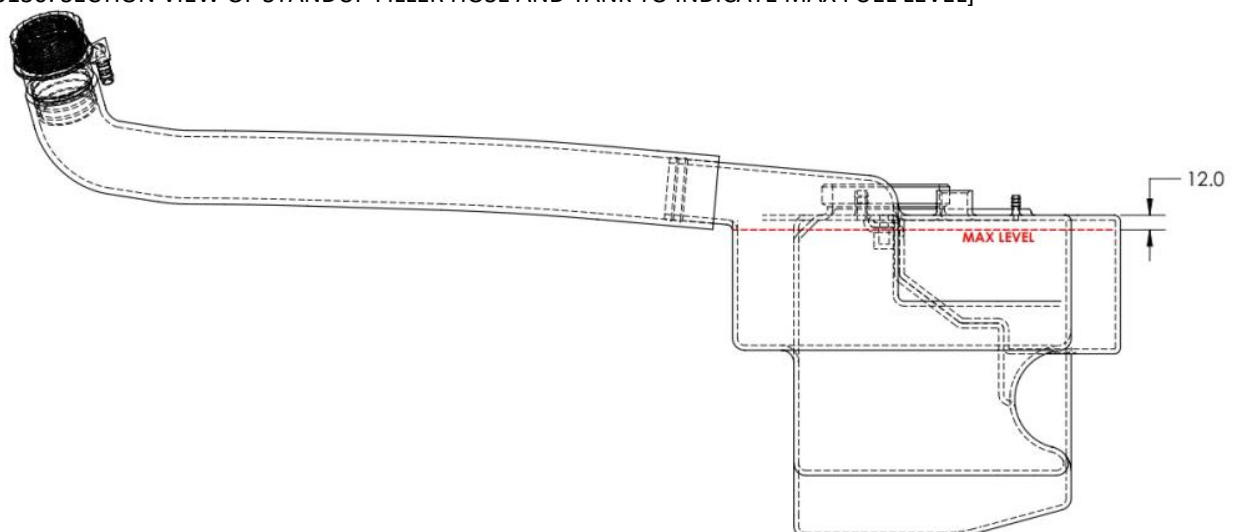

Reaper:

This model is fitted with an internal fuel filler system. To fill the fuel tank, open the hood, remove the filler cap, slowly add fuel until the fuel level is 12mm (1/2") from the top of the tank taking care to not overfill. Reinstall the filler cap securely and close the hood.

★ [IMG3140: SECTION VIEW OF REAPER FILLER HOSE AND TANK TO INDICATE MAX FUEL LEVEL]

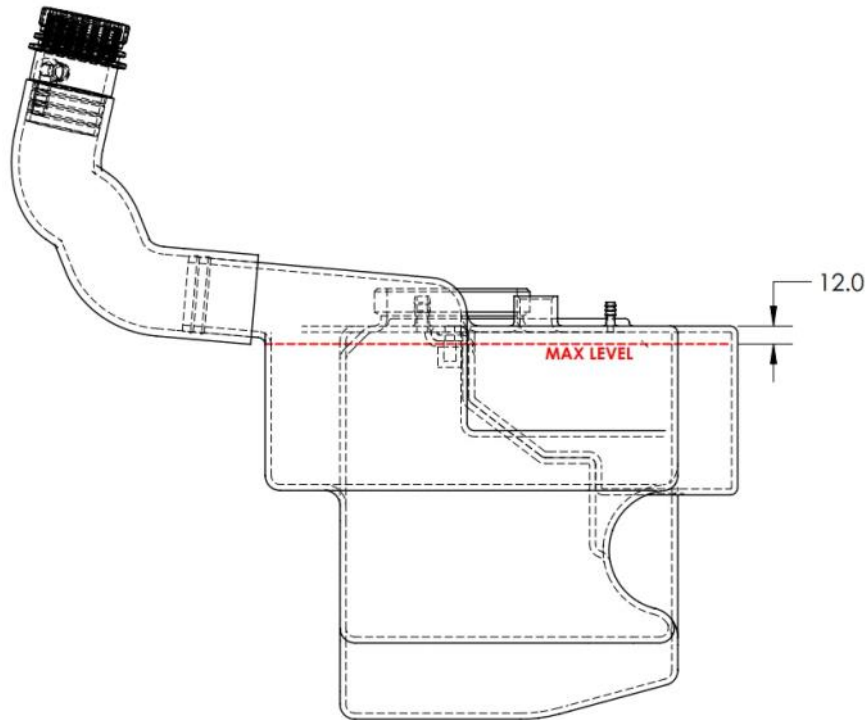

FILLING OIL TANK

CAUTION

DO NOT allow the oil level to drop to the minimum level mark, or 40mm from the bottom of the tank. Operating the watercraft with an insufficient supply of oil will cause engine damage. Always check the oil level before use.

The watercraft is fitted with an internal oil tank. To fill the oil tank, remove/open the hood, remove the oil tank cap, slowly add the recommended oil until the oil level is just below the top of the tank. Do not overfill. Once the tank has been filled, reinstall the oil tank cap and secure the hood.

★ [IMG3150: SECTION VIEW OF OIL TANK MAX AND MIN LEVEL]

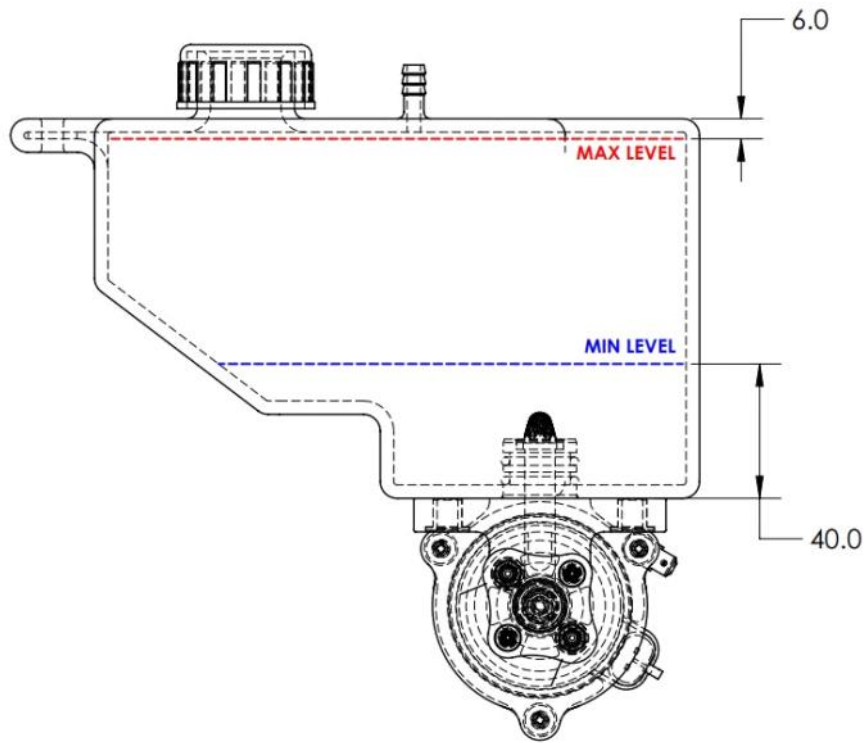

If the oil tank ran low, check the oil lines for air, and reprime if necessary. See "Priming" on page XX for more information. Always check the fuel and oil tank levels before use.

Controls

HANDLEBARS / STEERING

The Footrocket, Footrocket Pro and Pred-RR models have handlebars & steering are mounted at the end of the handle pole. There you will find the primary operation controls mounted beside at each handgrip.

★ [IMG3160: HANDLE CONTROLS FROM RIDER POV]



1. *Handle Pole*
2. *Handle Pole Pad*
3. *Handle Bars*
4. *Start Stop Switch*
5. *Throttle Lever*
6. *Trim Lever*

The Reaper model has handlebars and steering which are fixed to the hood of the craft. You will find the primary operation controls mounted beside at each handgrip.

★ [IMG3170: REAPER BARS AND CONTROLS]



1. Handle Bars
2. Start Stop Switch
3. Throttle Lever
4. Trim Lever

Steering functions much the same as a bicycle with the exception that you must apply throttle to turn. Turning only the handlebars will not turn the watercraft.

★ [IMG3180: REAR VIEW OF SKI]





IGNITION AND BILGE BUTTONS

The Footrocket, Footrocket Pro and Pred-RR models have ignition and bilge switches located above the foot tray of the hull on the left hand side. The Reaper model has the ignition and bilge switches on the hull to the left and right of the seat.

★ [IMG3190: CLOSE UP OF IGNITION AND BILGE BUTTONS STANDUPS]



1. Ignition Switch
2. Bilge Switch

★ [IMG3200: CLOSE UP OF IGNITION AND BILGE BUTTONS REAPER]

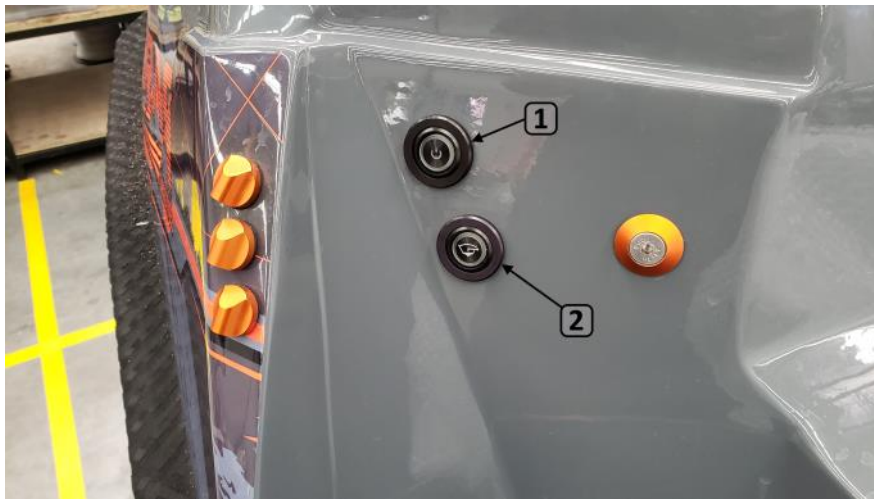

1. Ignition Switch
2. Bilge Switch

Press in the ignition switch in to turn on the ignition. The button will light up green when it is powered on. The ignition must be on to start the ski. When not riding, turn off the ignition to prevent accidental engine start.

Press in the bilge switch to turn on the bilge pump. The button will light up blue when it is powered on. It is recommended to always run the bilge pump when the watercraft is in the water.

START / STOP SWITCH

The Start/Stop switch is located on the left side of the handlebars.

★ [IMG3210: CLOSE UP OF START STOP SWITCH, FROM RIDER POV]

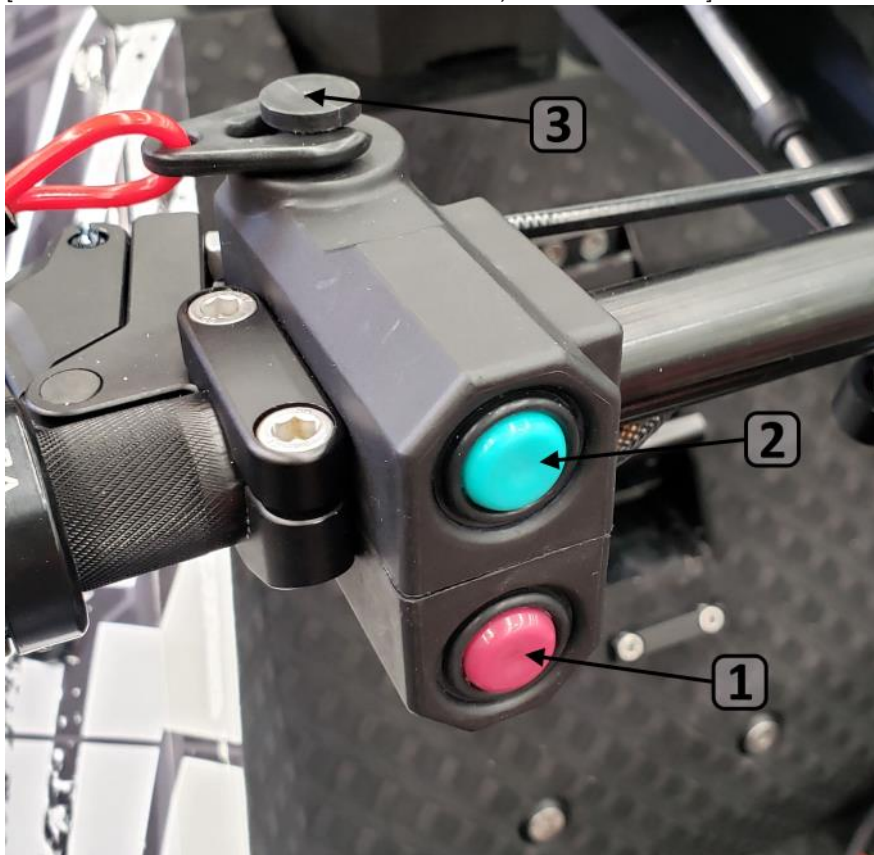

1. Red 'Stop' Button
2. Green 'Start' Button
3. Safety Lanyard (Engine Shut-off Switch)

Stop Button:

Press and hold the red 'stop' button to turn the engine off.

Engine Shut-Off Switch:

The safety lanyard must be clipped onto the 'engine shut-off switch' for the engine to run. Always attach the other end to the operator. This will stop the ski in the event of the rider falling off the watercraft.

WARNING

When not riding or running the engine always remove the safety lanyard to prevent unauthorized use or accidental engine start.

Start Button:

Press and hold the green 'start' button to start the engine (up to 5 seconds). Release once the engine has started. Allow the battery to recover for 30s between starting attempts.

CAUTION

DO NOT push the 'start' button while the engine is running. This can cause damage to the starting components.

DO NOT hold the 'start' button for more than 5 seconds. This can damage the battery, starter motor and battery cables.

THROTTLE LEVER

The throttle lever is located on the right side of the handlebars.

★ [IMG:3220: THROTTLE LEVER FROM RIDER POV]



Pulling the throttle lever in towards the handgrip increases the engine speed. When released it will automatically return the engine to idle speed. Before each ride ensure throttle operates smoothly and returns automatically when released.

TRIM LEVER

The trim lever is located on the left side of the handlebars.

★ [IMG3230: TRIM LEVER FROM RIDER POV]



Footrocket, Footrocket Pro & Reaper:

Pulling the trim lever in towards the handgrip angles the steering nozzle upwards, raising the bow. This is intended to make it easier to perform aerial manoeuvres. When released it will automatically return to level position. Before each ride ensure trim system operates smoothly and returns automatically when released.

Pred-RR:

Pulling the trim lever towards the handgrips angles the steering nozzle downwards, lowering the bow. This allows for better control of the ski in a fast launch because it reduces the amount of upwards pitch the rider experiences. When released it will automatically return to level position. Before each ride ensure trim system operates smoothly and returns automatically when released.

OIL PUMP CONTROLLER

The oil pump controller mounted on the fuel tank features a combination indicator light and button. When the ignition is powered on, the oil pump will perform an initialization cycle (pulse).

★ [IMG3240: OIL PUMP CONTROLLER]

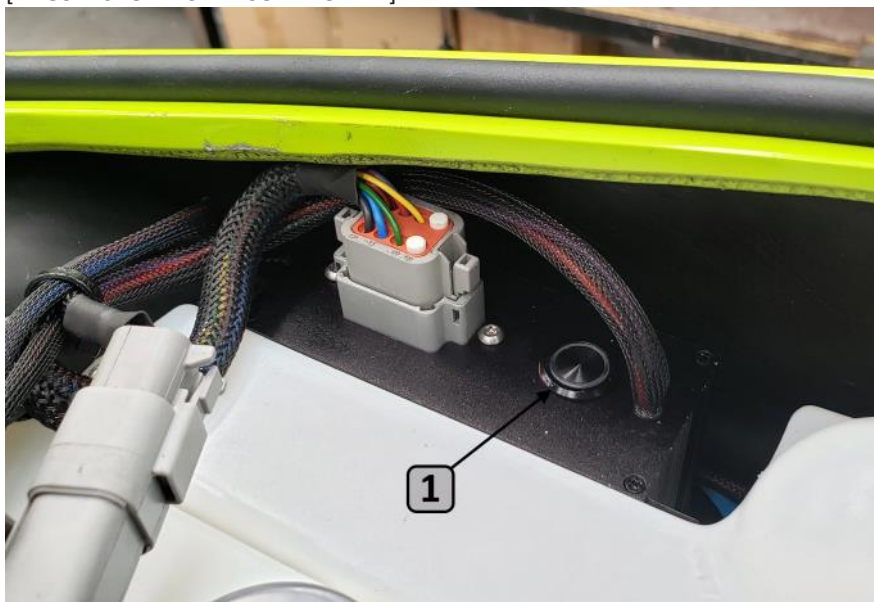

1. Combination indicator light & Button

The status lights description:

GREEN: Ok

BLUE: Initialization

RED: Communication issue (see troubleshooting guide [page XX](#))

During normal operation, the status light should be solid green. When the oil pump cycles, the green light will change to blue for 1/10th of a second, then back to green.

When the oil pump is performing the initialization cycle during start-up, the status light may be solid blue for up to 4 seconds. As the light returns to green, an audible 'click' should be heard.

The button can be pressed to manually cycle the oil pump (to pulse the oil pump once). This is used when priming oil lines. Do not press more than 1 time per second. See "Priming" on page XX for more information

Hood

FOOTROCKET, FOOTROCKET PRO

The Footrocket and Footrocket Pro hoods are secured with a hood latch, ratchet strap and hooks and prongs.

★ [IMG3250: FR/FR PRO HOOD OVERVIEW LABELLING EACH COMPONENT LATCH, RATCHET, HOOKS/PRONGS]

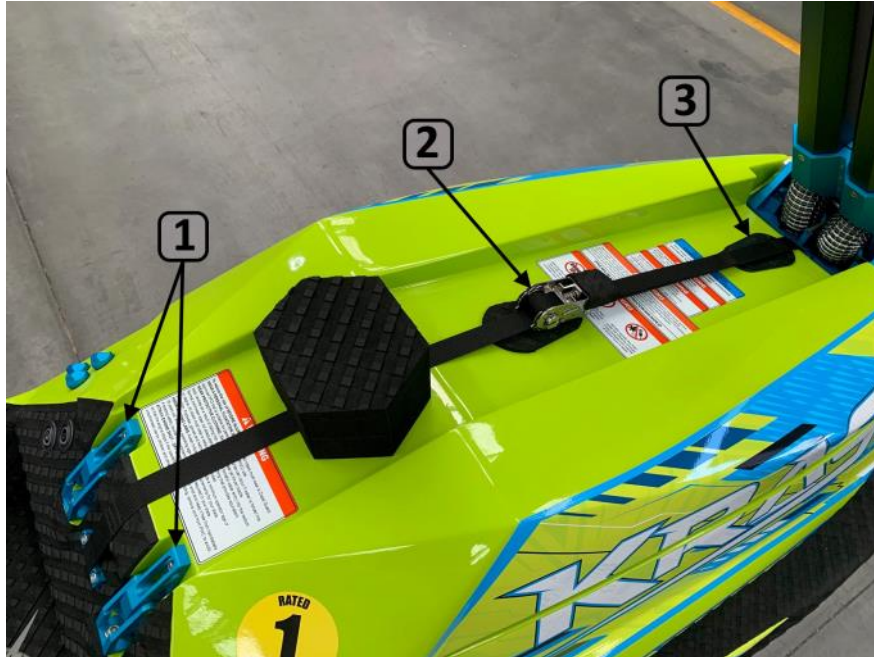

1. Hood Hooks & Prongs
2. Ratchet Strap
3. Hood Latch

To open hood:

1. Pull the release lever on the ratcheting lever and open past a vertical position. Release the release lever.
2. Then, while applying pressure against the ratcheting lever, pull the release lever away from the ratchet to allow the strap to loosen.

★ [IMG3260: RATCHET STRAP FULLY OPENED]



3. Repeat both steps until you are able to completely remove the strap from the ratcheting mechanism. Move to ratcheting mechanism out of the way to access the latch. Take care when handling the ratchet mechanism to avoid damaging the hull
4. On the hood (top, front) press down on the smaller, half-moon shaped button to release the hood latch.

★ [IMG3270: AERO CATCH CLOSED STATE]



5. Pull the latch lever upwards to release the locking pin

★ [IMG3280: AEROCATCH POPPED]



NOTE: It may be necessary to apply downward pressure (push down) to top of hood when pulling the latch lever to release the locking pin. This is due to the water-tight seal around the hood.

★ [IMG3290: AEROCATCH OPENED]

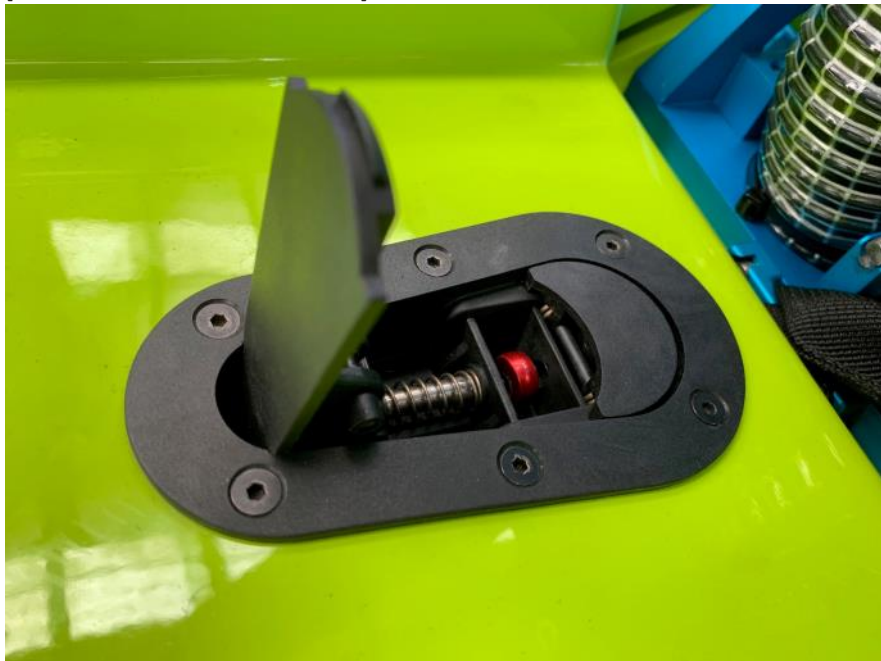

6. The hood can now be removed. Raise the steering pole upwards out of the way. Remove hood by raising front first, then disengaging the rear from the hooks and prongs.

To close hood:

1. To close the hood, lower the hood over the watercraft and engage the hooks and prongs together at the rear of the hood.

★ [IMG3310: HOOD HOOKS AND PRONGS ABOUT TO BE ENGAGED]



2. Ensure the hood hooks and prongs are correctly engaged.

★ [IMG3320: INCORRECT VS CORRECT HOOD ENGAGEMENT COMPARISON]



IMPROPERLY CLOSED

- Gap between hood and hull.
- Hood hook not fully engaged with hood prong.



PROPERLY CLOSED

- No gap between hood and hull.
- Hood hook fully engaged with hood prong.

3. Align the latch loop pin attached to the hull, with the latch housing on the hood and carefully lower the hood.

★ [IMG3330: PICTURE SHOWING LATCH LOOP PIN WHEN HOOD IS REMOVED - HOW TO ALIGN THE HOOD AT THE FRONT]



4. While applying downward pressure to hood, flip locking lever down until it locks.

NOTE: It may be necessary to apply pressure (push down) to top of hood to engage locking pin. This is due to the water-tight seal around the hood.

★ [IMG3340: PICTURE SHOWING LATCH READY TO BE CLOSED, AND ACTION DIRECTION]

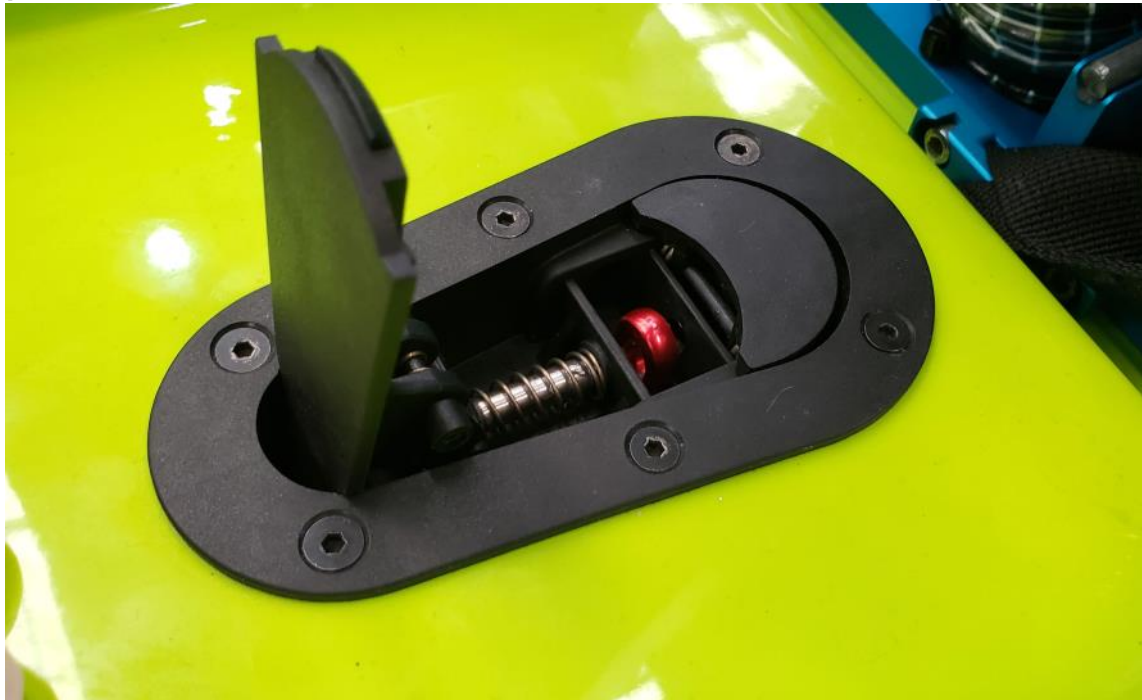

5. Open ratchet and rotate ratchet axle until slot is visible.

★ [IMG3350: RATCHET READY TO LOAD STRAP IN]



6. Thread strap through slot in ratchet axle, from the underside of the ratchet, back over the top of the handle

★ [IMG3360: RATCHET WITH STRAP BEING LOADED]



7. Tighten strap by cranking the ratcheting lever until strap is snug. Fold lever over to close.

★ [IMG3380: FULLY CLOSED RATCHET STRAP]



CAUTION

DO NOT over-tighten ratchet strap. DO NOT use ratchet strap alone to secure hood in place.

PRED-RR

The Pre-RR hood is secured with hooks and prongs, and a toggle latch. Alternatively it can be secured with the hooks and prongs, and a ratchet strap.

PRED-RR with Latch System

To open hood:

1. Lift the steering pole.
2. Pull up the latch to unlatch the hood.
3. Grasp the hood on both front and rear. Lift the rear by a little and push the hood forward and up.

To close hood:

1. Position the hood so that the 2 catches fit into the 2 hooks on the deck.
2. Pull the hood back and push downwards lightly until the rear edges line up.
3. Position the latch over the rear hook and push down on the handle until it toggles and locks.

REAPER

The Reaper hood and seat are on a hinge toward the nose of the ski, and secured with a ratchet strap at the base of the seat. There is a folding over centre hinge which will support the hood when opened fully.

WARNING

DO NOT open the hood of the watercraft in very windy conditions. The wind could cause the folding over centre hinge to disengage and cause the hood to suddenly shut causing severe injury

To open hood:

1. Pull the release lever on the ratcheting lever and open past a vertical position. Release the release lever.

★ [IMG3500: REAPER WITH OPENED RATCHET LEVER]

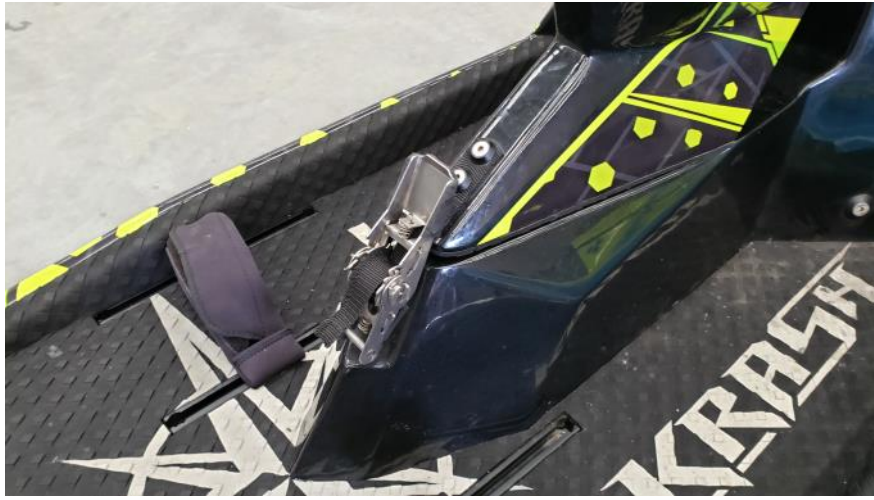

1. Then, while applying pressure against the ratcheting lever, pull the release lever away from the ratchet to allow the strap to loosen.
2. Remove the strap from the ratchet axel completely.
3. Lift the hood upwards, until the folding over centre hinge can be engaged. Slowly lower the hood slightly to allow the hinge to lock.

★ [IMG3510: OPEN REAPER HOOD WITH OVER CENTRE LATCH SHOW IN ENGAGED POSITION AND NON-ENGAGED]

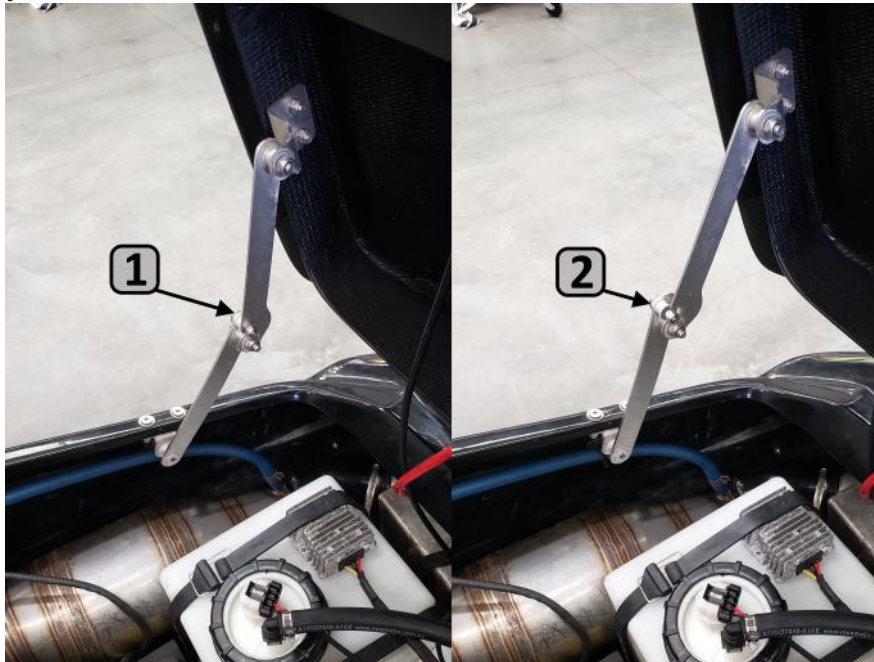

1. Latch Engaged
2. Latch disengaged

To close hood:

■ **WARNING**
When closing the hood, keep clear of the folding hinge and the hull-hood interface. The closing hood could cause serious injury if arms, hands or fingers are caught.

4. Slowly raise the hood until the over centre hinge can be disengaged. Disengage the hinge and lower the hood.
5. Align the seat with the protruding key in the hull

★ [IMG3520: PROTRUDING TRAPEZOID IN THE HULL WHICH ENGAGES WITH THE SEAT]



6. Open ratchet and rotate ratchet axle until slot is visible.

★ [IMG3525: POSITIONING THE RATCHET]



7. Thread the strap through ratchet.

★ [IMG3530: REAPER STRAP LOOSELY THREADED]



8. Due to the short length of strap, do not pull the strap fully through the axle before tightening. Leave approximately 50mm loose to allow ratchet to tighten.

★ [IMG3540: SHOW RATCHET THREADED BACK, READY TO TIGHTEN]



9. Tighten strap by cranking the ratcheting lever until strap is snug. Fold lever over to close.

■ **CAUTION**
DO NOT over-tighten ratchet strap.

Bilge System

Your craft is equipped with an electronic bilge system.

The electronic bilge pump is controlled by the bilge button on the outside of the hull above the foot tray, which will illuminate blue when powered on. It is recommended to always run the bilge pump when the watercraft is in the water.

The electric bilge pump is located inside the engine compartment, next to the driveline mid-shaft (short-shaft). Always check the bilge is working before launching the watercraft.

★ [IMG3550: ELECTRIC BILGE PUMP IN HULL]



WARNING

If bilge pump stops working, power off ignition and REMOVE safety lanyard before reaching into hull to check for blockage at bilge pump.

Operation

Friday, 18 November 2022 3:49 PM

Safety



WARNING

DO NOT consume alcohol or drugs before or during operation of a personal watercraft.

Always wear a U.S.C.G. approved personal flotation device suitable for use while riding a personal watercraft.

Users outside the US may have their own requirements; be sure to follow them. Contact your local maritime safety authority for up to date information.

Always wear suitable protective clothing while riding a personal watercraft. Severe internal injuries can occur if water is forced into body cavities as a result of falling into water or being near jet thrust nozzle. Normal swimwear does not adequately protect against forceful water entry into the rectum or vagina. All riders must wear a wetsuit bottom or clothing that provides equivalent protection. Footwear, gloves and eyewear are recommended.

A boater safety course is highly recommended, and may be required in your state or country.

The inherent nature of operating a personal watercraft requires the operator is in good health and able to swim competently. Do not ride farther from shore than the operator can swim back.

DO NOT apply throttle when anyone is near the rear of the watercraft. Water and debris exiting the jet pump can cause severe injury.

DO NOT reach into the intake grate, steering nozzle or exhaust when the watercraft is running, or could be started. Severe injury will occur.

Keep the intake grate clear of items such as clothing, long hair and PFD straps which could be sucked into the jet pump causing injury or drowning.

This is a high-performance personal watercraft intended for use by persons 16 years of age or older.

The operating capacity of 1 rider, the operator, should never be exceeded.

SAFE RIDING RULES

Learn and obey local and state laws governing operating your watercraft. Safe Boating Courses are recommended, and may be required in your state. Check local and state regulations before operating.

This craft is intended to be used by one person (operator) at a time. Operator's should be at least 16 years of age.

Do not sit or stand on the watercraft when not riding.

Prior to every ride inspect and verify all controls are functioning properly and freely.

While operating your watercraft maintain a safe distance from others. Do not follow other watercraft or boats too closely.

DO NOT attempt to spray or splash others with your watercraft.

Drive at safe speeds and scan your riding area constantly. Never ride past your point of ability or visibility.

Your watercraft is not equipped with a brake. Anticipate when you must stop and take early action to avoid collisions.

You need thrust to turn. Anticipate when you need to turn. Never completely release the throttle when trying to avoid or steer away from an obstacle.

DO NOT tow other watercraft or objects. The tie-down points at the bow and stern are for securing the craft during transport only.

DO NOT operate your watercraft after dark or before dawn.

Learn the proper procedure for righting your watercraft. It will not self-right if capsized. Attempt to right craft immediately after capsizing.

Do not operate your watercraft in water less than the depth up to your knees when standing (approximately 2 feet).

Avoid riding in areas where the water is full of debris and/or weeds.

Always ride with others nearby, especially if riding further away from shore than you can swim.

Always ensure the engine shut-off safety lanyard is attached to the operator prior to launching

RIDING GEAR

All riders are required to wear a U.S. Coast Guard approved Personal Flotation Device suitable for use on a personal watercraft. Check with your local watercraft dealer for recommendations and options.

Wear protective wetsuit bottom to prevent severe internal injuries that can occur when falling into the water while riding or being near the jet pump nozzle. Lycra, nylon or similar lightweight bathing suit material will not provide adequate protection.

★ [IMG4010: DIAGRAM OF RIDER WITH RECOMMENDED GEAR. WETSUIT, EYE PROTECTION, GLOVES, SHOES]

Eye protection, gloves and shoes are recommended. Check with your local watercraft dealer for recommendations and options.

Wearing a helmet can help prevent injuries, but can also lead to injuries in certain circumstances. A helmet can protect your head in the event there is a collision with another watercraft or hard object, but it can also cause injury if you fall into the water while riding.

WARNING

You must weigh the risks and benefits and decide for yourself whether or not to wear a helmet, when it is not required such as a competition. Check with your local watercraft dealer for recommendations and options.

EQUIPMENT

Vessels less than 16ft (4.8m) in length are required by the U.S. Coast Guard to carry one 'B-1' rated fire extinguisher on board while operating navigable waters under U.S. Coast Guard jurisdiction.

★ [IMG4020: B-1 RATED FIRE EXTINGUISHER INSTALLED IN HULL]



In addition, most states, parks, and wildlife departments require that a U.S. Coast Guard approved fire extinguisher be carried aboard on waters not under federal jurisdiction.

Users outside the US may have their own requirements regarding fire extinguishers; be sure to follow them. Contact your local maritime safety authority for up to date information.

WARNING
DO NOT use your watercraft unless it has a fire extinguisher on board.

You should carry sound and visual distress signalling devices. Check with your local watercraft dealer for recommendations and options.

ADDITIONAL SAFETY INFORMATION

More information on Boater Safety Courses and training can be found at:

www.uscgboating.org

www.boatus.org

Local law enforcement agencies.

NAVIGATION

RULES

Operating a personal watercraft should be done with the same regard as operating a car on the road. You are obligated to know and obey the rules of the water for the area in which you are riding. The rules that follow are provided as a reference for your convenience only. You should consult the local U.S. Coast Guard Auxiliary Post or Law Enforcement Agency for the complete set of rules governing the waters you will be operating on.

When two vessels meeting head-on while under way, only one vessel has the right-of-way; the “stand-on” (privileged) vessel. The vessel without the right of way is the “give-way” (burdened) vessel. Never assume other boaters will know or follow these rules. Always use caution when approaching or passing another vessel.

SAILBOATS:

Sailboats will almost always have the right of way. Steer clear and avoid creating wake that will disturb them.

OVERTAKING & PASSING:

When overtaking, or passing another vessel, the vessel you are passing has the right-of-way. You are required to steer clear of that vessel.

★ [IMG4030: OVERTAKING & PASSING DIAGRAM]

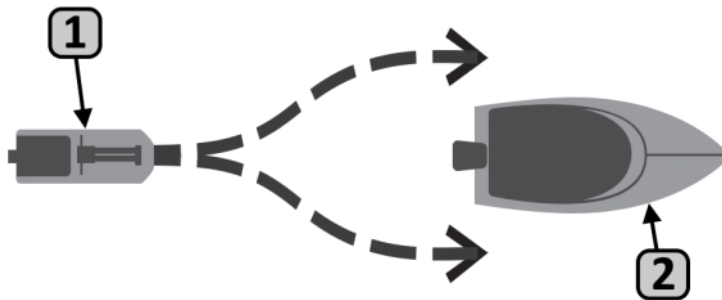

1. Give-way (Burdened) Vessel Overtaking
2. Stand-on (Privileged) Vessel Being Overtaken

MEETING:

When meeting another vessel head on, neither vessel has the right-of-way. Both vessels should keep to the right to pass.

★ [IMG4040: MEETING DIAGRAM]

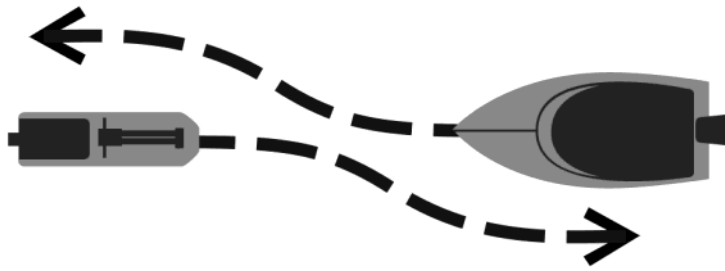

CROSSING:

A vessel on your right will have the right-of-way. Direct your course to starboard (right) and pass astern (behind) 'stand-on' vessel. If necessary, slow your vessel or reverse course to allow 'stand-on' vessel room to pass safely. Look for towed objects behind 'stand-on' vessel (tubes, water skier, etc.).

★ [IMG4050: CROSSING DIAGRAM]

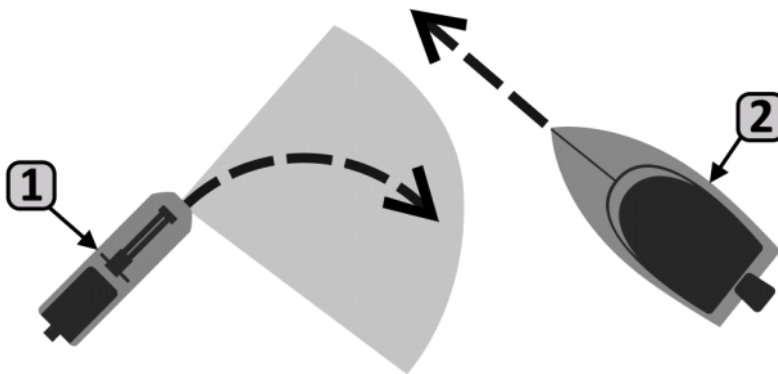

1. Give-way (Burdened) Vessel
2. Stand-on (Privileged Vessel Holds Course & Speed)

If you have a vessel on your left you have the right-of-way. Maintain your course and speed until clear.

Pre-Ride Checklist

Every time you take your watercraft out for a ride, it is recommended you complete the following checks to ensure your ride goes smoothly.

INITIAL CHECKS (HOOD OFF, ON THE STAND OR TRAILER, WATERCRAFT POWERED OFF)

Before launching the watercraft, in an open and well ventilated area, remove the safety lanyard from the start stop switch and open the hood.

1. Ventilate the engine compartment to clear any gasoline fumes
2. Check bilge pump is secure and functional.



WARNING

A build-up of gasoline fumes in the engine compartment could lead to a fire or explosion.

3. Check the battery is fully charged.
 - 12.6 V Minimum
4. Check the battery cables are correctly connected to the battery terminals, that the screws are tight, and that the covers are in place.
 - (-) on the black battery cable.
 - (+) on the red battery cable.



WARNING

Loose battery cables can create sparks which could cause a fire or explosion.

5. Visually check the oil level.
6. Ensure the oil filler cap is tightened correctly.
7. Check there is no air bubbles in the oil lines:
 - If there are air bubbles, follow the priming procedure. See "Priming" on page XX for more information
8. Visually check the fuel level.
9. Ensure fuel filler cap is tightened correctly.
10. Check the bilge system is working by switching it on and listening for operation:
 - It is advised to leave the bilge pump on when the watercraft is running in the water
11. Visually check if all electrical looms and water hoses are connected and secure.
12. Check the spark plug caps are securely connected to the spark plugs by pushing down on them.
13. Visually check and inspect exhaust hoses for damage, or signs of damage or leaks at connecting points. Ensure hose clamps are tight and not damaged.
14. Check the fire extinguisher for any damage, and that it is suitably charged, and is secure in the mounting location.
15. Check for smooth Throttle cable operation:
 - Pull and release the throttle lever several times while watching the throttle wheel on the throttle bodies.
 - Check that the cable and wheel operate smoothly, and returns to the closed position when the cable is released.

WARNING

Any rough or hard spots can cause loss of control due to throttle being held open.

16. Check for smooth Steering cable operation:
 - Move the handle bars side to side several times while watching the steering nozzle.
 - Check that nozzle moves side to side smoothly and freely.

WARNING

Malfunction of the steering system can cause collisions resulting in severe injury.

17. Check for smooth trim cable operation:
 - Pull and release the trim lever several times while watching the steering nozzle.
 - Check that the nozzle moves up and down freely.
18. Check for smooth Handle pole operation:
 - Move the handle pole up and down several times.
 - Check that it moves freely and is not loose in any way.
 - Check the pivot bushings to ensure they are not worn or damaged.
19. Check the adjustable footholds are secured, and that you are able to easily remove foot with footwear on.
20. Check the intake grate, jet pump and steering nozzle are clear of any obstructions.
21. Check the intake grate is tightly secured. If it is loose, tighten the mounting screws.
22. Check the hull for any damage.

ENGINE CHECKS (HOOD OFF, ON THE STAND OR TRAILER, WATERCRAFT POWERED ON)

After completing the above checks, with the hood still off, attach the safety lanyard to the engine shut-off switch on the start stop switch. Please pay attention to device noises as the ignition is switched on.

1. Press the ignition button on the hull to power on the watercraft

HALTECH ECU ONLY:

- i. Listen for the sound fuel pump running for approx. 3 seconds
 - ii. Check for the white light on the ECU
 - If there is no light, check ECU fuse.
 - ⊖ If problem persists, contact your Dealer or support@kavincimotors.com
2. Check for the green light light on the Oil Pump Controller
 - If no light, check the oil pump fuse
 - If red light, check connections
 - ⊖ If problem persists, contact your Dealer or support@kavincimotors.com
 3. Listen for the sound of the oil pump performing the initialization cycle when the status light turns green.
 - If no pulse, check the oil pump connections
 - ⊖ If problem persists, contact your Dealer or support@kavincimotors.com
 4. Start the engine by pressing the Green Start button
 - Do not hold the start button for more than 5 seconds.
 - Let the battery recover and the engine cool down for 30 seconds between starting attempts



WARNING

Do not run the engine in a closed area. Exhaust gases contain carbon monoxide. Breathing exhaust gas leads to poisoning, asphyxiation and death



CAUTION

Do not run the engine without water for more than 10 seconds. Overheating will cause engine damage.

5. After a few seconds. Stop the engine by holding the Red Stop button.
6. Start the engine again, by pressing the Green Start Button
7. After a few seconds, remove the safety lanyard and ensure the engine stops.
8. Switch the ignition off.

FINAL CHECKS (HOOD ON, ON THE STAND OR TRAILER)

At this point the ski is ready for the final steps before launching into the water.

1. Close the hood and secure it shut.
2. Ensure fuel filler cap is tightened.
3. Check the scupper bung is correctly closed.

POST-LAUNCH CHECKLIST

After launching the watercraft on the water always check the following:

1. Verify water is flowing out of all bypass water cooling outlets on top, left side of hull. The flow should change with the engine speed. If the flow is low, immediately discontinue use and do not run the engine until the source of the issue is found.



[IMG4060: WATER FLOWING FROM WATER OUTLETS]



CAUTION
Low flow from the bypass water cooling outlets are signs of a blockage or fault in the cooling system which will lead to overheating. Overheating will cause engine damage

2. The safety lanyard must be attached to your person, either with the soft loop secured around your left wrist or to the front of your PFD.
3. Check the electronic bilge is switched on

WARNING
DO NOT operate your watercraft if you are unable to successfully perform, complete or check-off any step of the Pre-Ride & Post-Launch Checklists. Repair or replace the item in question or contact your local watercraft dealer for Assistance.

First Time Operation: Pump Nozzle Assembly

First Time Operation: Engine Break-in

CAUTION
Failure to perform proper engine break-in could result in reduced engine life and/or severe engine damage. During engine break-in period DO NOT ride in surf conditions or competitions. Ride on calm, flat water only.

FIRST TANK

Check the fuel tank is filled and ride while moderating your throttle position between 25% - 50%, varying your speed and blipping to 100% throttle occasionally. Ride for 15 minutes then bring the craft in and allow to cool down for 15 minutes. Repeat this process until you have used a full tank of fuel.

Remove the safety lanyard and open the hood to check over all fuel lines, oil lines, cooling lines and exhaust hoses for leaks or loose connections. Inspect steering and throttle components to ensure they are functioning properly and secured properly. Insert the safety lanyard, power on the ignition and check the oil board light turns green.

SECOND TANK

Refill the fuel tank with fuel and ride while moderating your throttle position between 50% - 75%, varying your speed and blipping to 100% throttle occasionally. You may accelerate to full speed periodically, but for no more than 4 - 5 seconds at a time. Ride for 15 minutes then bring the craft in and allow to cool down for 15 minutes. Repeat this process until you have used a full tank of fuel.

Remove the safety lanyard and open the hood to check over all fuel lines, oil lines, cooling lines and exhaust hoses for leaks or loose connections. Inspect steering and throttle components to ensure they are functioning properly and secured properly. Insert the safety lanyard, power on the ignition and check the oil board light turns green.

BREAK-IN INSPECTION

At this point your engine will be broken in. Go over the craft thoroughly following the inspection points outlined in the 'Pre-ride Checklist' on page XX.

Check the following bolts and re-torque as necessary:

Cylinder Head	12x M8	27 N-m [20 ft-lbs]
Exhaust Centre Section	3x M10	40 N-m [30 ft-lbs]
Cylinder	6x M10	40 N-m [30 ft-lbs]

★ [IMG4070: DIAGRAM OF BOLTS TO CHECK]

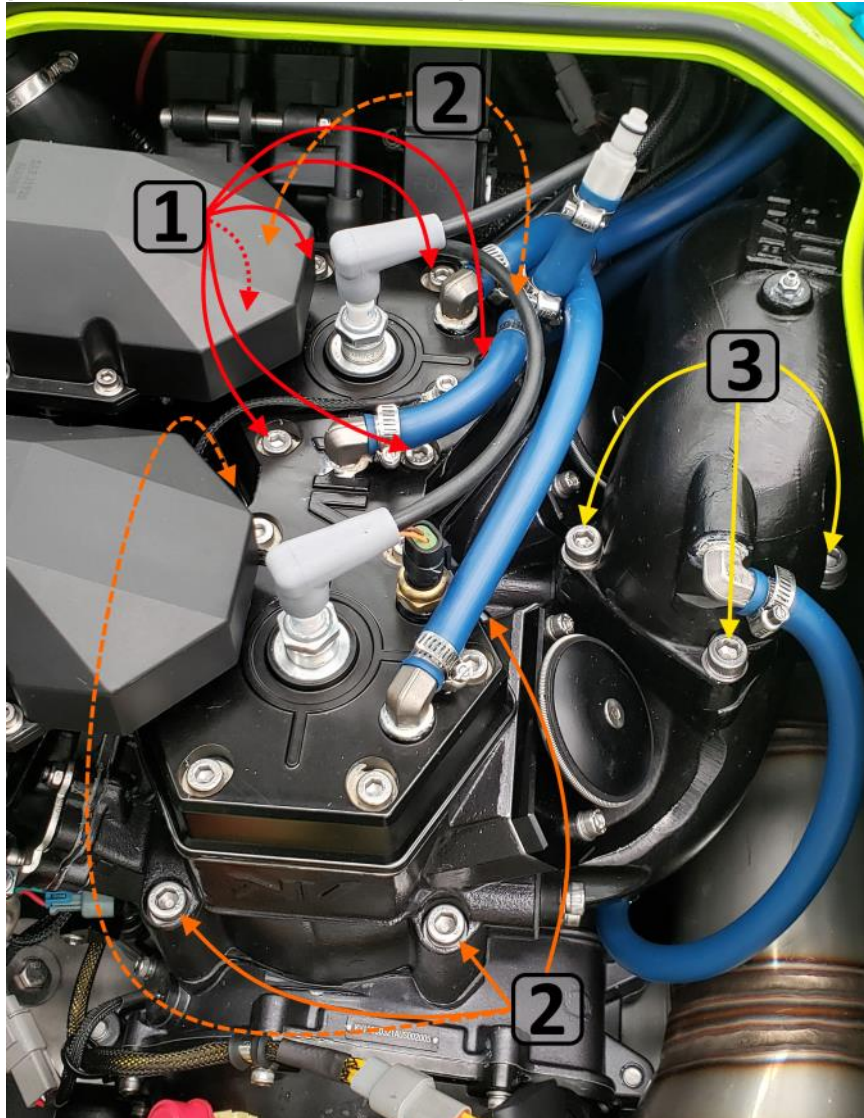

1. Cylinder Head (12x M8)
2. Cylinder (6x M10)
3. Exhaust Centre Section (3x M10)

Or, contact your local dealer to arrange for them to perform the inspection and maintenance.

Once you have inspected the craft you may operate it normally in surf conditions and competitions.

Starting/Stopping Engine

STOPPING ENGINE

The engine can be stopped in one of two ways:

- Press and hold the 'RED' stop button on the bottom of the switch, until the engine stops.
- Remove the safety lanyard from the 'ENGINE SHUT-OFF SWITCH'

★ [IMG3210: CLOSE UP OF START STOP SWITCH, FROM RIDER POV]

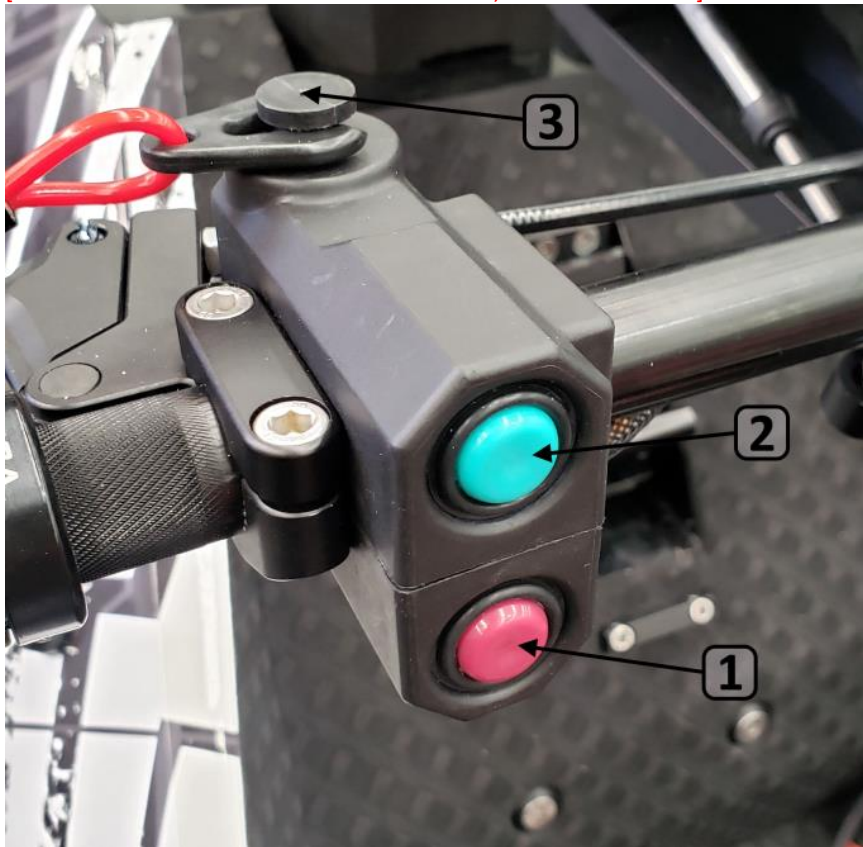

STARTING ENGINE

To start the engine install the safety lanyard onto the 'ENGINE SHUT-OFF SWITCH'. Power on the ignition and wait a few seconds. Press and hold the 'GREEN' start button on the switch until the engine starts, but for no longer than 5 seconds. Wait at least 30 seconds between starting attempts.

CAUTION

DO NOT hold the 'start' button for more than 5 seconds. This can damage the battery, starter motor and battery cables.

DO NOT push the start button while the engine is running. This can cause damage to the starting components

WARNING

When not riding or running the engine always remove the safety lanyard to prevent unauthorized use or accidental engine start.

LAUNCHING

SHALLOW WATER START: STAND-UP MODELS

Secure the safety lanyard to start/stop switch and your person, and power on the ignition. While standing in at least 2ft of water that is clean and free of debris, grab handlebars with both hands. Raise one knee up and place in foot tray. Point the craft in the direction of open water, scanning ahead and side to side.

★ [IMG4080: PERSON STANDING IN WATER BEHIND STANDUP SKI, READY TO START AND TAKE OFF]

While scanning ahead and side to side, start the engine. With the handlebars straight accelerate. Begin to raise your other knee into the foot tray, so you are kneeling. Thrust from the jet pump is required for both stability and steering.

WARNING

Use caution when riding in a kneeling position. DO NOT ride with your chin directly above handle pole.

★ [IMG4090: PERSON RIDING STANDUP SKI SLOWLY ON KNEES]

As you accelerate the bow of the watercraft will drop, and the watercraft will level out. Once the watercraft has levelled out (known as planing) the throttle can be reduced to suit the riders preference.

Once you are underway and balanced, move to a standing position, keeping your knees slightly bent and your upper body weight close to the handlebars.

★ [IMG4100: PERSON RIDING STANDUP SKI STANDING]

DEEP WATER START: STAND-UP MODELS

Secure safety lanyard to start/stop switch and your person, and power on the ignition. Grab handlebars with both hands and pull yourself up into foot tray so you are kneeling.

★ [IMG4110: PERSON KNEELING ON STANDUP TRAY IN DEEP WATER]

With the craft pointed in the direction of open water, scanning ahead and side to side, start the engine. With the handlebars straight accelerate.

WARNING

Use caution when riding in a kneeling position. DO NOT ride with your chin directly above handle pole.

Once you are underway and balanced, move to a standing position, keeping your knees slightly bent and your upper body weight close to the handlebars.

★ [IMG4100: PERSON RIDING STANDUP SKI STANDING]

SHALLOW WATER START: REAPER

Secure safety lanyard to start/stop switch and your person, and power on the ignition. While standing in at least 2ft of water that is clean and free of debris, grab rear of seat with both hands. Board craft, kneeling on rear deck. Transfer your hands to the grips and point the craft in the direction of open water, scanning ahead and side to side.

★ [IMG4120: PERSON KNEELING ON BACK OF REAPER, READY TO START AND TAKE OFF]

While scanning ahead and side to side, start the engine. With the handlebars straight accelerate. Begin to raise your body up and over the seat.

★ [IMG4130: PERSON SITTING ON REAPER SEAT]

As you accelerate the bow of the watercraft will drop, and the watercraft will level out. Once the watercraft has levelled out (known as planing) the throttle can be reduced to suit the riders preference.

Once you are underway and balanced move, to a standing position, keeping your knees slightly bent and your upper body weight just over the handlebars.

★ [IMG4140: PERSON RIDING REAPER SKI STANDING]

DEEP WATER START: REAPER

While floating along left side of watercraft secure safety lanyard to start/stop switch and your person, power on the ignition. Grab handlebars with both hands and start the engine.

★ [IMG4150: PERSON FLOATING, READY TO START AND TAKE OFF]

With the craft pointed in the direction of open water, scanning ahead and side to side, begin accelerating and pulling your upper body onto and over the seat and your knees onto the rear deck.

★ [IMG4160: PERSON PULLING THEMSELVES OVER THE BACK OF THE REAPER SEAT]

Once you are underway and balanced, move to a standing position, keeping your knees slightly bent and your upper body weight just over the handlebars.

★ [IMG4140: PERSON RIDING REAPER STANDING]

Stopping Watercraft

Your watercraft is not equipped with a brake. Take early action to avoid collisions or running aground. The rate at which you stop is dependent upon the rate of speed you are traveling. The faster you are traveling the longer it will take to stop.

As you slow down, the rear of the craft will begin to lower. Be prepared to get off the watercraft as it comes to a stop in shallow water to prevent damaging the hull, jet pump and engine.

Pressing the 'STOP' button or unclipping the safety lanyard from the 'ENGINE SHUT-OFF SWITCH' will stop the watercraft the fastest. Do this when you approach shore or shallow water to prevent damaging the hull, jet pump and engine.

Releasing the throttle lever while the engine is running stops the craft more slowly, but provides you with control by enabling you to turn by accelerating. This helps avoid obstacles while maintaining control.

NOTE: At full speed expect it will take approximately 300 feet (90m) for the watercraft to come to a complete stop in a straight line.

WARNING
Stopping distance will vary depending upon speed, riding conditions, rider weight and rider ability.

WARNING
DO NOT stop the engine if you will need to steer while slowing down. Thrust is required to steer the watercraft.

Driving

TURNING

Turning your watercraft requires the following:

- Rotating the handlebars.
- Leaning into the turn.
- Thrust (applying throttle).

WARNING
Do not turn suddenly. Scan area first! Do not release the throttle when trying to avoid or steer away from an obstacle. You need thrust to turn.

For a gradual, slow turn - gently lean and slightly turn the bars in the direction you wish to turn, using moderate thrust to complete the turn.

For a tighter, fast turn - lean more and turn the bars more heavily in the direction you wish to turn, using more thrust (throttle).

RIDING

Unless you are already an experienced watercraft rider it will take some time to achieve the skill necessary to enjoy riding your craft proficiently. Take the time to learn basic techniques for operating your watercraft. Vary the throttle to get a feel for how engine speed affects turning and acceleration. Vary your body position to learn how it affects handling and turning.

WARNING
Use caution when riding in a kneeling position. Do not ride with your chin directly above handle pole.

RIGHTING CAPSIZED WATERCRAFT

WARNING
This watercraft will not right itself if capsized. Do not reach into intake grate or steering nozzle. Remove safety lanyard from engine shut-off switch immediately. You must follow the proper procedure for righting the craft as soon as possible. Do not allow the engine to run when the watercraft is capsized as water will enter the engine causing immediate engine damage.

If you capsize your watercraft you must turn it over (right it) as soon as possible. Firstly stop the engine by removing the safety lanyard from the engine shut-off switch immediately.

Swim to the rear of the watercraft. While grasping both corners, pull down on the right and push up on the left, rotating the watercraft clockwise.

★ [IMG1020: PICTURE OF PERSON IN WATER BEHIND SKI WITH CORRECT ROTATION DIRECTION]

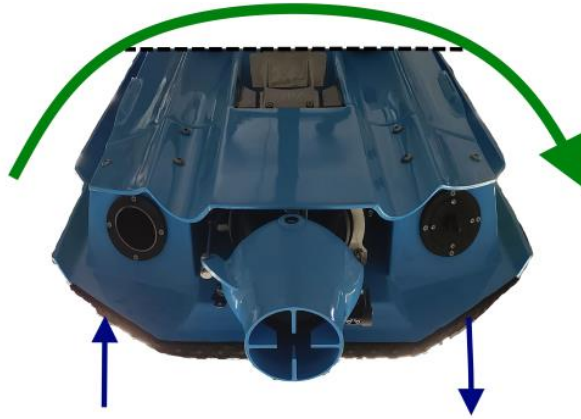

If watercraft was capsized for a short period of time it may be started and run again. Insert the safety lanyard and run the engine at 50% - 75% throttle until water is no longer exiting the bilge pump outlet.

CAUTION

Do NOT rotate capsized watercraft counter-clockwise. Serious engine damage could result. If the watercraft was capsized for an extended period of time, began to sink, or did sink, water could have entered the engine. Do NOT start the engine. You must follow the procedure for removing water from the engine first (see pg.XX). Serious engine damage will occur.

End of ride procedure

At the end of a day of riding, follow these few steps to clear out water from the engine compartment, engine and off the hull. Extended exposure to saltwater can reduce the life of the watercraft and it's components. If storing watercraft for more than 30 days, see "Storage" on page xx.

CAUTION

Personal Watercraft are not designed to be docked or stored in the water for prolonged periods of time. Doing so can cause accelerated deterioration of the jet pump components and hull finish and the craft could sink. Always remove your watercraft from the water when you are not riding for extended periods of time. Never leave it in the water overnight.

CLEARING THE EXHAUST SYSTEM

To clear water from the exhaust system, once the watercraft is out of the water:

1. Place the craft on a level surface
2. Check the intake grate on the bottom of the hull is clear of anything that may get dragged into or tangled in the pump
3. Insert the safety lanyard and power on the ignition switch.
4. Start the engine and let it idle for a 3 - 5 seconds.
5. Rev the engine to 50% throttle 2 - 3 times.
6. Remove the safety lanyard and switch off the ignition.

CAUTION

DO NOT run the engine up to full speed. DO NOT run the engine for more than 15 seconds without supplying water. Both of these will cause engine damage.

FLUSHING THE COOLING SYSTEM

You must flush the cooling system after every use in saltwater or contaminated water (sand or debris). NOTE: We recommend using a salt remover/inhibitor solution when flushing your cooling system.

1. Place the craft on a level surface.
2. Check the intake grate on the bottom of the hull is clear of anything that may get dragged into or tangled in the pump
3. Remove hood to access flush connection on engine.

4. Connect the garden hose to the flush kit adapter, keeping the water supply off.
5. Insert the safety lanyard and power on the ignition switch.

★ [IMG4170: FLUSH KIT IN OPERATION, PLUGGED INTO NEW WATER ROUTING MOTORS]



6. Start engine and allow to idle 3 - 5 seconds.
7. Turn water supply on. Flush for 1 - 2 minutes maximum.
8. Turn water supply off.
9. Rev engine up to 50% throttle 2 - 3 times.
10. Remove safety lanyard and power off ignition switch.
11. Disconnect garden hose.

CAUTION

DO NOT rev the engine up to full speed. DO NOT run the engine for more than 15 seconds without supplying water. DO NOT run the engine on flush kit for more than 2 minutes. ANY OF THESE WILL CAUSE ENGINE DAMAGE!

CLEANING

It is important that you wash your watercraft inside and out after every use, especially in saltwater.

1. Clean and rinse off outside of watercraft.
 - Steering controls, steering pole, hood, hull, foot tray, intake grate, jet pump and exit nozzle all need to be rinsed
2. Remove hood. Clean and rinse engine and engine compartment. Take care not to spray water into or near air intakes
3. Be sure to rinse away trapped salt water as much as possible, in areas such as:
 - Bolt counterbores (cylinder head and cylinder block)
 - Shaft Seals (engine output shaft, midshaft and pump shaft)
4. Remove bung from rear of ski and tilt backwards to drain.

★ [IMG3560: SCUPPER VALVE/BUNG OUTLET AT REAR OF HULL]



5. Dry entire watercraft inside and out.
6. Lubricate moving components with spray silicone or WD-40:
 - Throttle & Trim Lever
 - Throttle, Trim & Steering Cable
 - Steering Nozzle & Trim Ring Bushings
 - Hood latch
 - DO NOT lubricate handle pole bushings.
7. Set hood in place, leaving propped open to allow airflow and to prevent condensation inside the engine.

CAUTION

DO NOT use high pressure water supply. Thoroughly dry watercraft components and engine compartment. Apply corrosion inhibitor to engine compartment components.

Special Procedures

Friday, 18 November 2022 3:49 PM

Steering Nozzle Installation

Your watercraft has been packed and shipped new without the Steering Nozzle & Trim System installed. Prior to first use of the watercraft, the Steering Nozzle and Trim Ring will need to be installed to the rear of the watercraft.

1. Locate and unwrap the pre-assembled Steering Nozzle and Trim Ring
★ [IMG5011: STEERING NOZZLE & TRIM RING PACKAGED]



2. Remove the custom head screw and washers from both sizes of the exit nozzle.
★ [IMG5012: REMOVING NOZZLE BOLTS]



3. Apply Loctite 263 (Red) to one of the screws.

4. Reinstall the screw through the washer into the Exit nozzle on the starboard (right) side.

5. Locate the hole in the Trim Ring over the screw head on the Exit nozzle



[IMG5014: INSTALLING TRIM RING OVER ONE SIDE]



6. Insert the washer between the Trim Ring and Exit Nozzle and align the holes.



[IMG5016: ALIGN AND INSERTING WASHER BETWEEN TRIM RING & EXIT NOZZLE]



7. Apply Loctite 263 (Red) to the remaining screw.

8. Install the screw through the Trim Ring and washer, into the Exit Nozzle.



[IMG5018: INSTALLING NOZZLE BOLT]



9. Torque Both screws to 16 Nm.

10. Remove the bearing retaining screw from the Trim Ring.

★ [IMG5022: REMOVING TRIM RING WHEEL]



11. Feed the wire cable around the wheel and Apply Nickel Anti-seize to the screw threads.

★ [IMG5024: FEEDING THE WIRE CABLE]



12. Insert the wheel under the shroud and reinstall the screw. Tighten to 6 Nm.

★ [IMG5026: REINSTALLING TRIM RING WHEEL]



13. Attach the Steering Cable to the Ball End on the Steering Nozzle.

★ [IMG5028: INSTALLING STEERING CABLE OVER BALL]



Check the range of motion on the steering by turning the bars, checking for smooth operation. Also pull the trim lever a back and forth a few times, checking for smooth operation. The Trim Ring and Steering Nozzle is now installed and ready to be used.

Clearing Jet Pump

The jet pump can become clogged with weeds or debris causing cavitation and reducing speed, even though the engine accelerates. The jet pump controls the engine cooling. Continuing to run your watercraft with a clogged jet pump can cause engine damage due to overheating.

WARNING

Remove safety lanyard! DO NOT attempt to remove debris while the engine is running. Severe injury will occur.

1. Stop the engine and bring your watercraft up onto shore.

2. Remove safety lanyard and power off the ignition.

3. Roll watercraft onto left side.

★ ~~[IMG5010: HULL ON LEFT SIDE ON BEACH, HOOD ON]~~

4. Inspect jet pump intake and jet pump.

5. Remove debris.

Jump Starting Engine

If your battery has been run down it should be charged before operating your watercraft. If that is not possible you may jump start your watercraft using a booster or another watercraft's battery.



WARNING

DO NOT attempt to remove, replace or jump start battery if there is a smell of gasoline. Allow engine compartment to ventilate and clean any spilled fuel from engine compartment first. Gasoline fumes may be ignited by sparks when connecting booster.



CAUTION

Use 12V booster only.

In case of jumpstarting with another battery, make sure the battery required the specifications

For a booster, follow the instructions provided with the device.

When Jump starting using another battery.



WARNING

DO NOT REVERSE POLARITY (DO NOT CONNECT + TO -).

1. Connect positive cable (red) between positive (+) terminals first.

2. Connect negative cable (black) to negative (-) battery terminals.

3. Start engine.

4. Disconnect cables in reverse order of above.

Submerged Watercraft

If your watercraft becomes submerged and/or the engine compartment fills with water you must drain immediately and purge the engine by following the procedure below.



WARNING

DO NOT attempt to start the engine until you have purged the engine of water.



CAUTION

Drain engine compartment completely. If water has entered the engine (water ingestion) corrosion will destroy the cylinder, crankshaft and bearings within a few hours.

Draining the Hull:

1. Bring craft ashore (See "Towing Watercraft" on page XX)

2. Remove safety lanyard and power off ignition.

3. Remove hood.
4. If scupper or bilge pump are not operational, drain the craft by rolling it onto left side taking care not to damage handle pole & steering.

★ [IMG5020: HULL ON LEFT SIDE ON BEACH, HOOD OFF]

5. Roll ski back upright.

Purging the Engine:

1. Unplug the hall effect sensor on the intake side of the engine.

★ [IMG5030: HALL EFFECT SENSOR PLUG LOCATION IN HULL]



2. Remove spark plugs caps from the spark plugs.
3. Remove spark plugs.
4. Insert safety lanyard onto the start stop switch.
5. Power on the ignition switch.



WARNING

Keep clear from above the spark plug holes as water and gasoline will be forcibly ejected through spark plug holes

6. Press and hold the green 'START' button for 3 - 5 seconds.
7. Wait 15 seconds, and repeat until water is no longer ejected through spark plug holes.
8. Remove safety lanyard and power off the ignition.

Inspecting the Fuel Tank:

1. Inspect fuel tank for water intrusion. If water is present you must drain and refill with fresh fuel.
2. Remove the fuel pump, and use an external pump or siphon to drain the tank from the

opening.

3. After draining, reinstall the fuel pump and fuel pump cap. Refill with fuel



WARNING

Fuel and fuel vapours are extremely flammable and can be explosive. DO NOT smoke around fuel systems. Always remove safety lanyard from start stop switch, check the area is well ventilated and the area is free from sources of flames or sparks, before working with fuel or fuel systems.



WARNING

Gasoline is toxic and flammable. Properly dispose of contaminated fuel at a recycling depot.

Restarting the Engine:

1. Install new spark plugs.
2. Reconnect the spark plug caps.
3. Reconnect the hall effect sensor.
4. Insert safety lanyard onto the start stop switch.
5. Power on the ignition switch.
6. Attempt to start engine.
 - If engine does not start remove spark plugs and check them for signs of water (droplets on plug or milky colour)
 - If there are signs of water, remove lanyard and repeat steps in "Purging the Engine"
 - If the engine cannot be started within a few attempts follow the steps below in "Protecting the Engine"
7. If the engine starts, relaunch the watercraft and operate in water for at least 10 minutes to completely clear out engine and exhaust system.
8. After riding, thoroughly clean and lubricate craft. See "End of ride procedure" on page XX and "Cleaning and protecting watercraft" on page XX for more information.

Protecting the Engine:

1. If the engine cannot be restarted it requires service at your nearest dealer or mechanic as soon as possible.
2. Remove the safety lanyard and power off the ignition.
3. Unplug the hall effect sensor.
4. Remove spark plugs caps from the spark plugs.
5. Remove the spark plugs.
6. Pour approximately 250ml of heavy premix (a mixture of equal parts fuel and oil) into each cylinder, down the spark plug holes.
7. Connect the safety lanyard, and power on the ignition.



WARNING

Keep clear from above the spark plug holes as water and gasoline will be forcibly ejected through spark plug holes

8. Crank the engine over by holding the start button for 5 seconds to coat the internal surfaces.

Towing Watercraft

If you must tow your watercraft attach a line at least 20ft long to the bow cleat. Tow watercraft no faster than 5mph.

Towing can cause water to enter the engine through the cooling system, and cause engine damage.



CAUTION

DO NOT allow passengers to ride watercraft in tow. DO NOT Tow faster than 5MPH (8 KPH or 4 knots). Doing so can flood the engine and engine compartment.

Overheating

Your watercraft is equipped with three engine cooling bypass outlets. Flow should increase as engine speed increases when in the water. When running, water should feel warm to the touch, but not hot.

Stop the engine immediately if water:

- ◆ Is flowing slowly
- ◆ Is not flowing from all three outlets
- ◆ Is not increasing with engine speed

Bring the craft ashore and check the jet pump intake for debris. If clear, check the engine cooling lines; verify they are connected and free of obstruction. Do not run the watercraft until the source of the problem is found.



[IMG5040: WATER TELLTALE OUTLETS ON OUTSIDE OF HULL]



CAUTION

Overheating will cause severe engine and exhaust system damage. DO NOT run engine until source of problem is identified and corrected.

Oil Line Priming

The crank case of the engine is supplied with oil via hoses connected between the oil pump and the engine. The oil ports on the engine are just below the fuel rail, on the intake side of the engine. There is one check valve on each oil hose to reduce the chance of oil draining into the engine or air entering the hoses.

★ [IMG5050: OIL INJECTION LINE LOCATIONS]



It is essential that the oil lines are kept completely full. Any air or air bubbles in the lines will cause the engine to not receive lubrication (when the air is injected rather than the oil) and cause significant engine damage.

■ CAUTION

After installation, break in, service or repair check the lines for air, and if present follow the "Priming" process below.

★ [IMG5060: PICTURE OF OIL LINES WITH AIR POCKET, COMPARING TO NO AIR POCKETS]



Priming

To prime the oil lines:

1. Disconnect the safety lanyard and power off the ignition

2. Remove the hood
3. Reach into the engine bay and locate the oil ports beneath the fuel rail
4. Detach the both hoses from the engine:
 - i. Squeeze the spring clamp tails and slide off the barbs.
 - ii. Pull the hoses off the barbs.
5. Unscrew the cap of the oil tank and feed the free ends into the opening.

★ [IMG5070: OIL LINES FED BACK INTO OIL TANK, READY TO BE PRIMED]



6. Insert the safety lanyard and switch on the ignition
7. Wait for the oil pump controller's light to turn green
8. Press the light/button on the oil pump controller, to cycle (pump) the oil pump
9. Repeat the above step (8), until BOTH of the lines are completely free of air
10. Remove the safety lanyard and power off the ignition
11. Reattach the hoses to the engine:
 - i. Push the hoses onto the barbs
 - ii. Squeeze the spring clamp tails and slide the clamp over the barbs to secure
12. Reinstall the oil tank cap
13. Resecure the hood

Fuse and Relay replacement

The electrical system features a fuse box mounted to the E-Bar at the rear of the engine compartment.

★ [IMG5080: FUSE BOX LOCATION PICTURE]



When changing or checking relays and fuses, first disconnect the safety lanyard and switch off the ignition.

★ [IMG5090: FUSE BOX AND RELAY LAYOUT]

PFI - Fuse Box 22'



Description	Component
Main Relay	Mini ISO 280 Relay 12V/30A
Fuel Relay	Mini ISO 280 Relay 12V/30A
Main Power	30A
Regulator	20A
Oil Board	15A
Coils	15A
Bilge Pump	10A
Injectors	10A
Fuel Pump	10A
Power Button	5A
Fuel Signal	5A
Starter	5A
ECU	3A

CAN	3A
-----	----

When replacing the lid, ensure it correctly latches on both sides by pressing down firmly.



WARNING

DO NOT replace a fuse with the incorrect capacity. Always replace a blown fuse with the correct capacity specified by the table above.

Care & Storage

Friday, 18 November 2022 3:49 PM

Storing your watercraft

To preserve the quality, performance and appearance of your watercraft, after each day of riding, follow the steps to:

1. Clear the Exhaust system
2. Flush the cooling system
3. Rinse the externals and engine compartment

For detail see "End of ride procedure" section on page xx.

When storing for a longer period of time (greater than 30 days) such as at the end of a season, it is recommended to follow the steps below to ensure good working condition when ready to ride again.

Prior to storing watercraft for an extended period of time (30 days or more) it is important that you properly prepare your watercraft so it will be ready to ride with minimal preparation when the times comes to use it again.

PREPARATION FOR STORAGE

1. Flush the cooling system. Afterwards blow air through the system to purge excess water.

WARM CLIMATES: Pump a salt inhibitor solution through the lines, allowing it to remain in the cooling system to prevent corrosion. NOTE: It may help to breakdown/reverse any build-up present in cooling system.

COLD CLIMATES: Pump an 'Aluminium Safe' anti-freeze solution through the lines, until it has fully circulated through the system. Stop the pump and allow it to remain in cooling system to prevent damage if temperatures drop to below freezing.

2. Remove air box covers and flame arrestor screens. Wash screens in degreasing solution and allow to dry completely. Replace flame arrestor screens, leaving air box covers off.
3. Insert the safety lanyard and power on the ignition. Start the engine and spray fogging oil into the top of each throttle body simultaneously. The engine may stop. **Do not run the engine for more 15 seconds.**
4. Disconnect the safety lanyard, then unplug the spark plug caps and set aside. Remove both spark plugs. Spray fogging oil into each cylinder through the spark plug holes.
5. Unplug the hall effect sensor on the intake side of the engine

WARNING

Keep clear from above the spark plug holes as oil and gasoline will be forcibly ejected through spark plug holes

6. Insert the safety lanyard and power on the ignition. Press and hold the green 'START' button for 3 - 5 seconds to circulate fogging oil.
7. Remove safety lanyard and power off the ignition.
8. Reconnect the hall effect sensor
9. Spray fogging oil on spark plugs and reinstall them. Reinstall the spark plug caps.

WARNING

Fuel and fuel vapours are extremely flammable and can be explosive. DO NOT smoke around fuel systems. Always remove safety lanyard from start stop switch, check the area is well ventilated and the area is free from sources of flames or sparks, before working with fuel or fuel systems.

10. Prevent condensation forming in the fuel tank by filling the fuel tank with fresh fuel, until it is almost completely full.
11. Disconnect battery cables (negative - first, positive + second) and remove battery. Apply dielectric grease to battery cable ends and to battery terminals. Store battery in a cool, dry place. NOTE: It is recommended you use a slow, trickle charger at least once per month to maintain battery charge.



WARNING

Use only a battery charger suitable for sealed-type batteries.

CLEANING AND PROTECTING WATERCRAFT

1. Wash and dry exterior and interior thoroughly.
2. Wax painted and clear-coated surfaces.
3. Apply light-weight spray silicone on engine compartment components and all exposed metal components outside of watercraft.
4. Clean and lubricate the following components with an aerosol cable lubricant:
 - Throttle and Trim Cable (both ends)
 - Steering Cable
 - Steering and trim ring pivots
 - Hood latch



[IMG6010: THROTTLE AND TRIM CABLE SPRAY POINT]



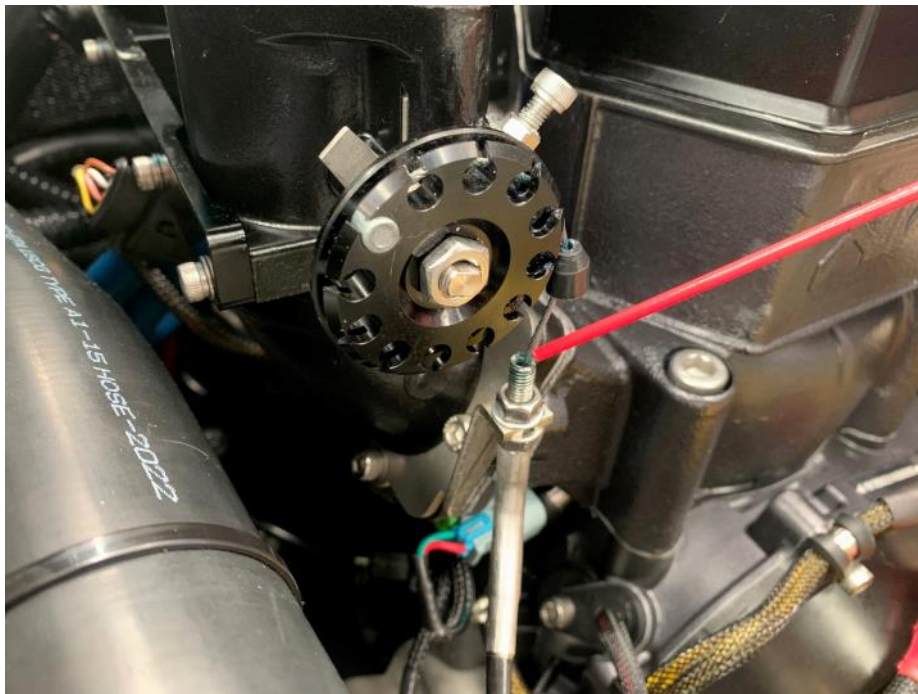

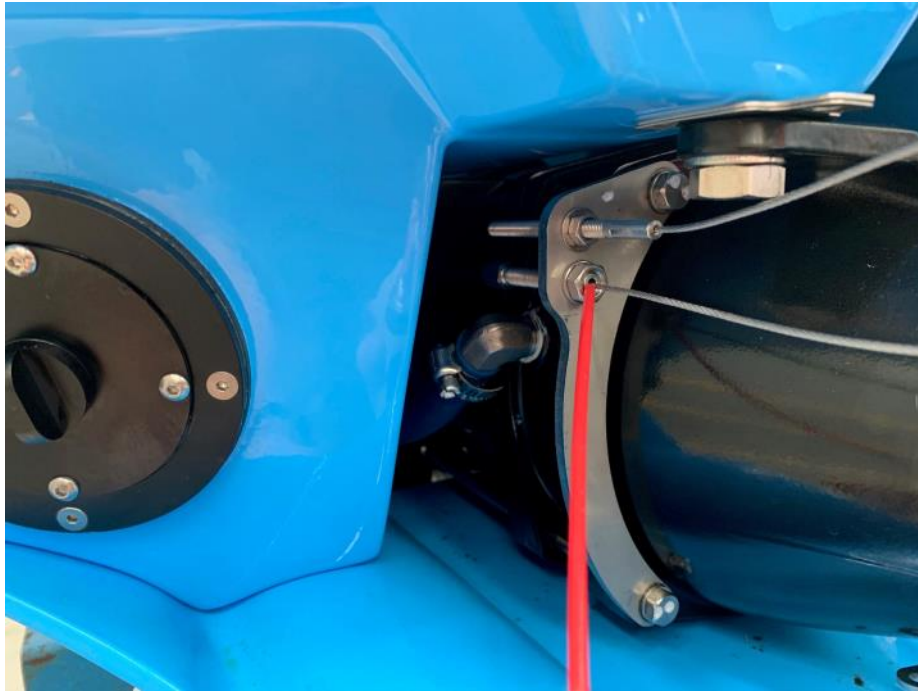

★ [IMG6020: STEERING CABLE SPRAY POINT]

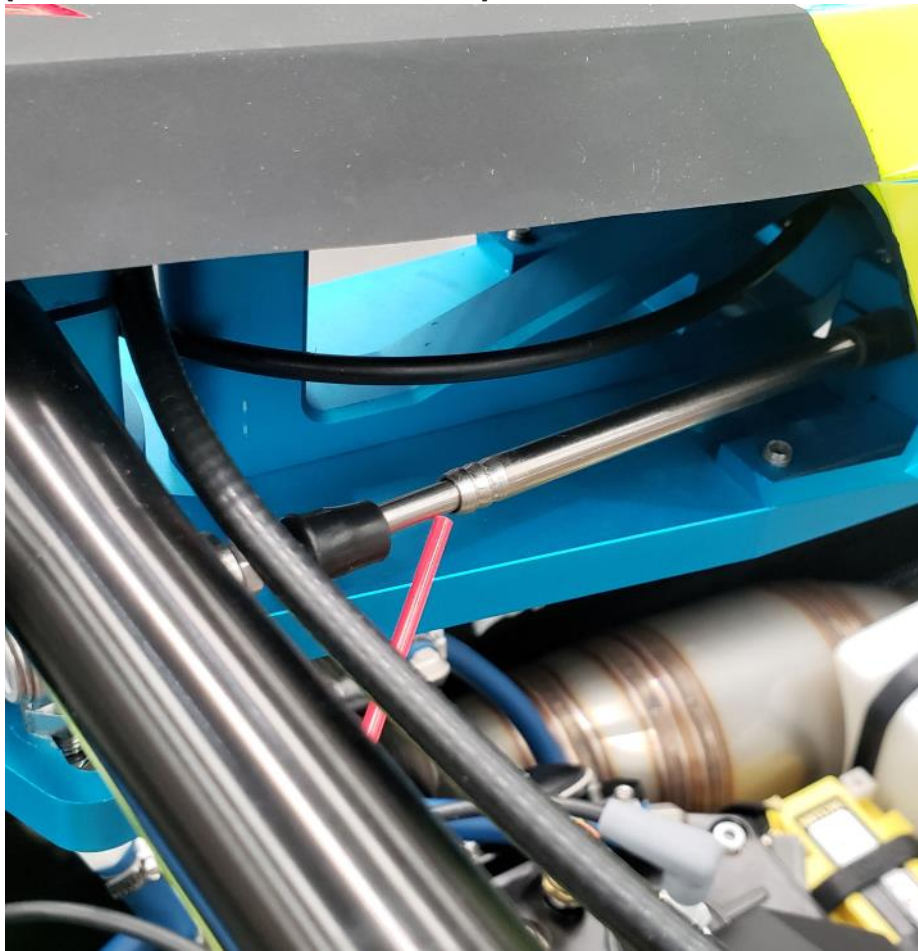

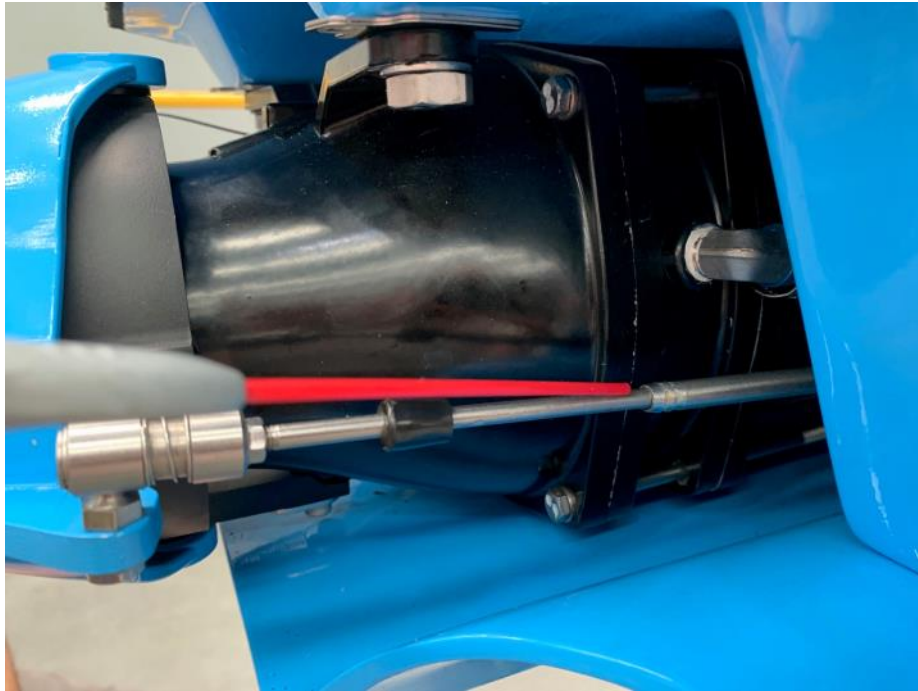

★ [IMG6030: STEERING AND TRIM RING POINTS]

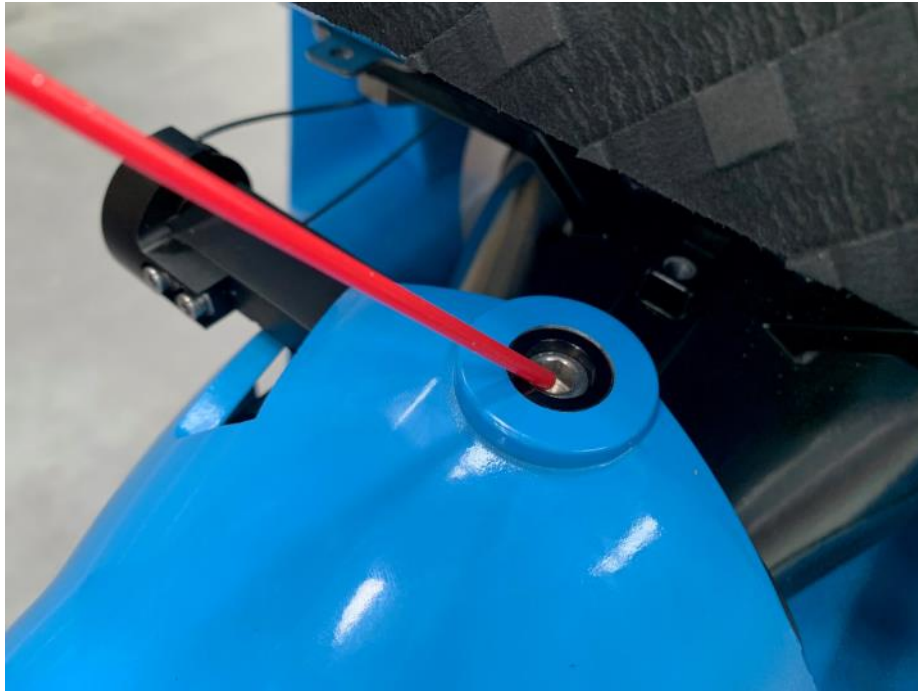

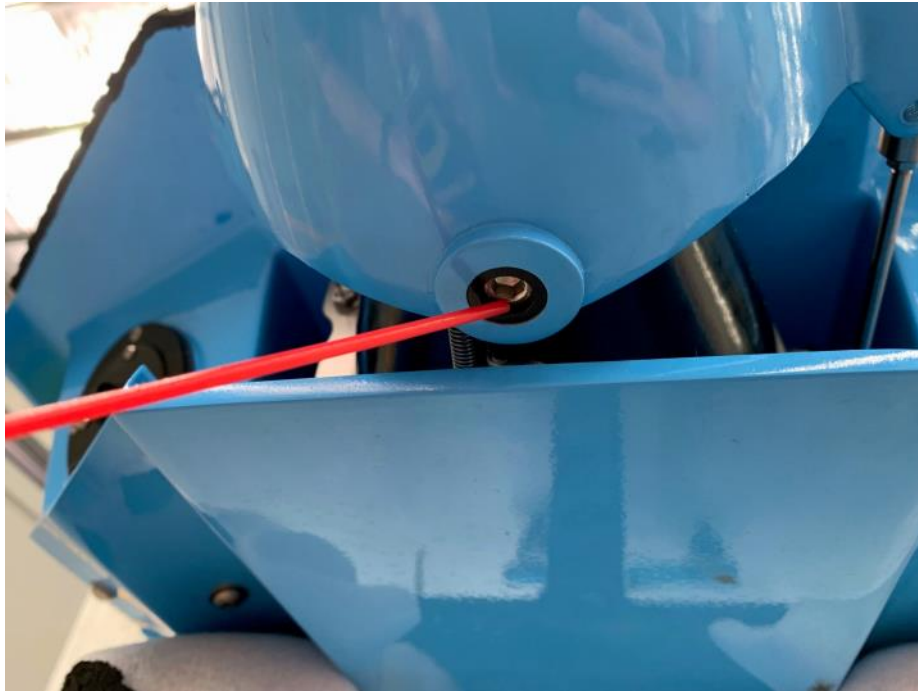



★ [IMG6040: HOOD LATCH SPRAY POINTS]

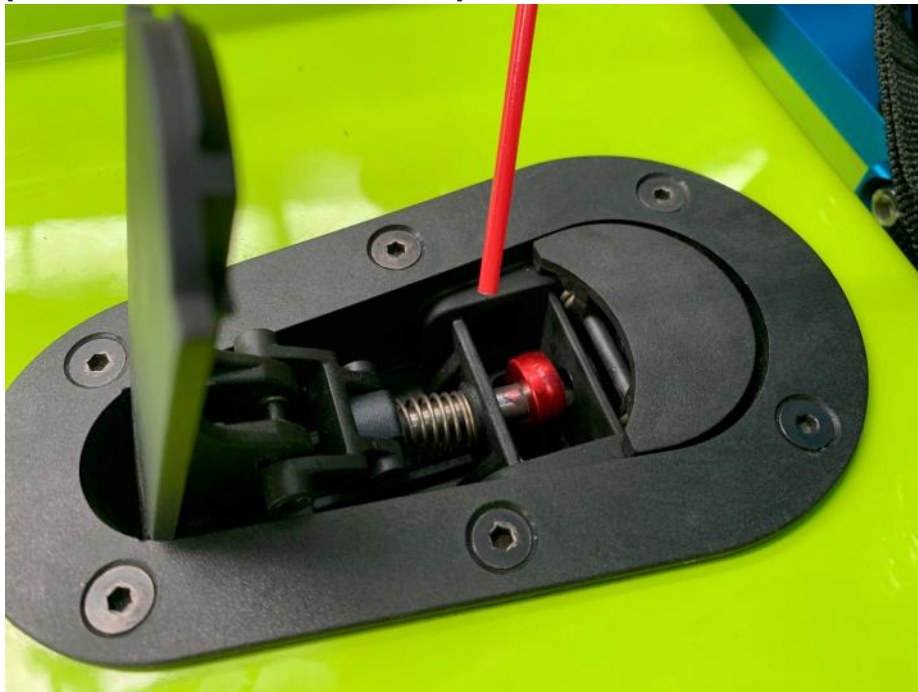

5. Clean and lubricate the following components with marine grade grease:
 - Throttle lever and Trim lever
 - Throttle cable fitting (on the throttle wheel)
 - Ball Joint
 - Shaft Seals (engine output shaft, midshaft)

★ [IMG6050: THROTTLE AND TRIM LEVER GREASE LOCATION]



★ [IMG6060: THROTTLE WHEEL GREASE POINT]



★ [IMG6070: STEERING BALL JOINT GREASE LOCATION]



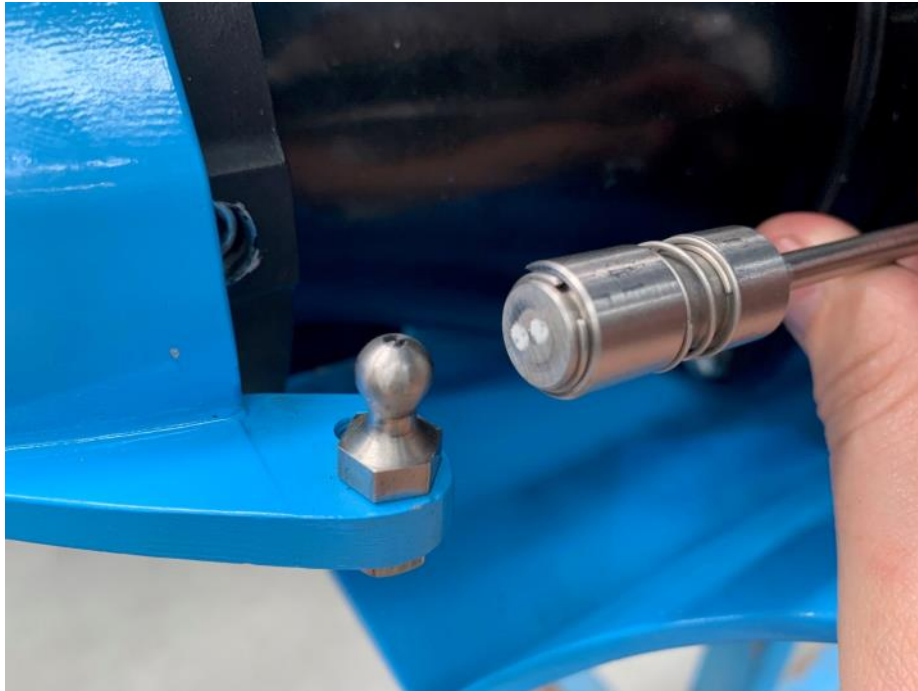

★ [IMG6080: SHAFT SEAL LOCATIONS]

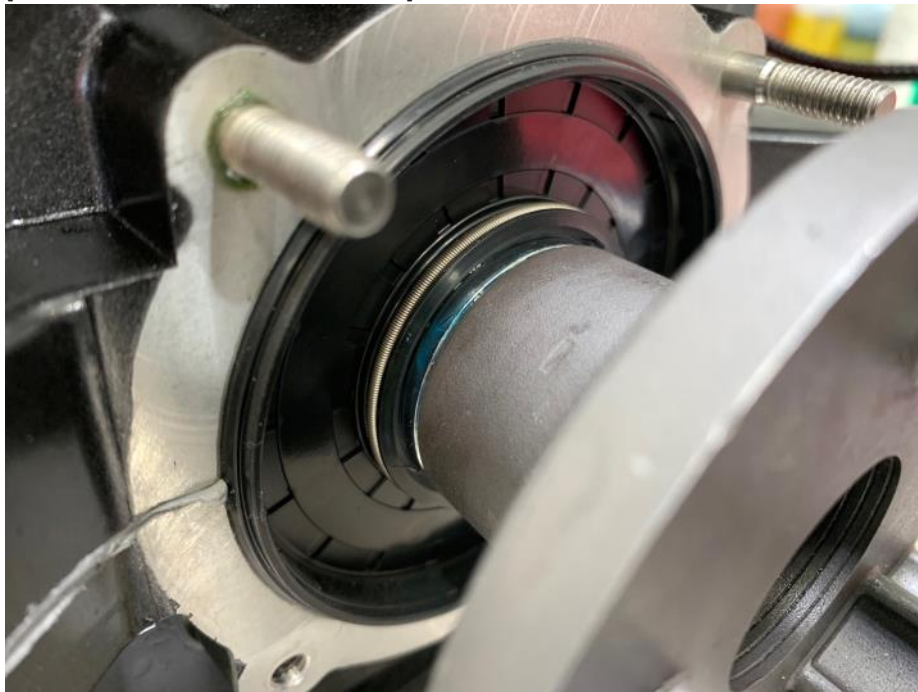



6. Set hood in place, but do not secure. NOTE: Prop hood open slightly to provide ventilation and stop condensation forming inside the engine.
7. Stuff a bright coloured rag into end of exhaust outlet to prevent animals from making a new home!
8. Cover watercraft and store in a clean, dry location indoors.

CAUTION

If you are unable to store your watercraft indoors, raise the bow to prevent water from collecting in the foot tray. Water left in the foot tray can cause the mats to deteriorate and peel off.

PREPARATION FOR RIDING

Following extended storage it is necessary to prepare your watercraft for riding again.

Uncover and inspect watercraft:

1. Remove hood and safety lanyard.
2. Inspect all hoses and wires inside engine compartment for damage, stiffness, or looseness. Replace any that are damaged or their condition is questionable.
3. Operate steering, throttle and trim. Check for sticking or binding of moving parts. Lubricate or replace as needed.
4. Remove and inspect spark plugs. Replace if necessary, reinstall if ok.
5. Inspect jet pump for foreign objects.
6. Reinstall battery. Positive (+) first, negative (-) second. Slide terminal covers over terminals.
7. Remove rag from exhaust outlet.
8. Fill fuel tank with fresh premium fuel. Secure filler cap.

WARNING

Fuel and fuel vapours are extremely flammable and can be explosive. DO NOT smoke around fuel systems. Always remove safety lanyard from start stop switch, check the area is well ventilated and the area is free from sources of flames or sparks, before working with fuel or fuel systems.

9. Fill or top up oil tank with the recommend oil (MOTUL 710 2T). Secure oil tank cap.
10. Check for air bubbles in the oil lines. If there are air bubbles, follow the priming procedure. See "Priming" on page XX for more information
11. Install the safety lanyard, power on the ignition and start the ski.
 - It may take a few attempts to start the ski as the fuel system will not be primed. Never hold the start button for more than 5 seconds. Wait 30 seconds between attempts for the battery to recover

CAUTION

DO NOT hold the 'start' button for more than 5 seconds. This can damage the battery, starter motor and battery cables.

12. After running the engine for 15 seconds, stop and inspect for fuel and exhaust leaks. Repair as needed.
13. Before riding perform 'PRE-RIDE CHECKLIST' procedure outlined on page XX.

Maintenance

Friday, 18 November 2022 3:49 PM

Adjustment Points

HANDLE POLE LENGTH ADJUSTMENT(STANDUP'S ONLY)

The length of the handle pole can be adjusted up to 50mm (2.0 in).

To adjust the pole:

1. Loosen the 3x M6 Socket Head Cap Screws in the centre of the top of the pole bracket (5mm Hex Bit)
2. Slide the steering assembly to the desired height. Always make sure there is at least 55mm of pole inserted into the bracket

CAUTION

DO NOT overextend the pole. Ensure there is a minimum of 55mm of tube inserted into the bracket.

3. Tighten the 3x M6 Socket Head Cap Screws to resecure the pole (8.0Nm)

★ [IMG7010: TOP OF POLE STEERING ADJUSTMENT, SHOWING MINIMUM ENGAGEMENT LENGTH]

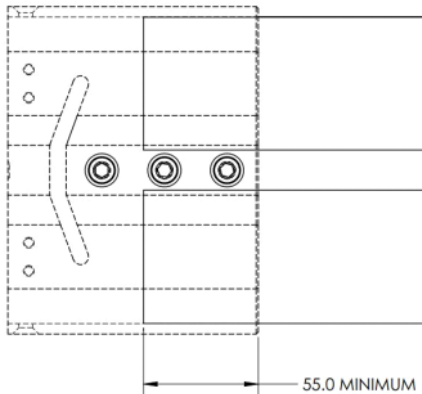

HANDLE POLE STIFFNESS (STANDUP'S ONLY)

The resistance of the handle pole can be adjusted to suit the riders preference. The pole is fitted with a torsion spring to assist in lifting, but it will not lift the pole alone.

To adjust the stiffness:

1. Remove the hood
2. Hold the pole bolt head (22.0 A/F)
3. Loosen the locknut (22.0 A/F)
4. To increase stiffness: Tighten the pole bolt.
5. To decrease stiffness: Loosen the pole bolt.
6. To set, while holding the pole bolt head, tighten the locknut to secure.

★ [IMG7015: POLE BOLT AND NUT LOCATION WITH ADJUSTMENT TOOLS IN PLACE]

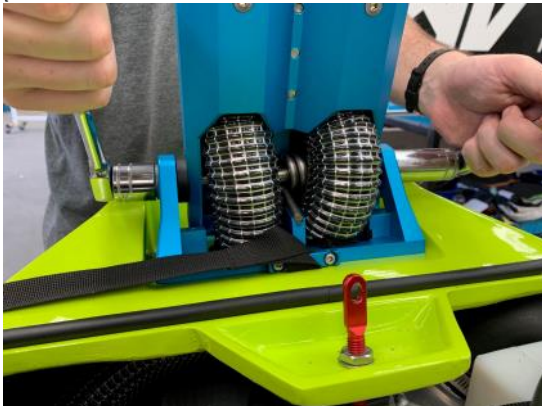

WARNING

DO NOT overtighten pole bolt. Replace pole bushes if excessive tightening is required to secure pole.

HANDLE BAR ROCK ADJUSTMENT (STANDUP'S ONLY)

Over the life of the ski, the handle bars can begin to rock as components wear in. This can be adjusted by tightening a lock nut on the underside of the steering pole.

To reduce the steering rock:

1. Tighten the M10 Nut (17mm A/F)
2. Check the amount of rock has been reduced.
3. Check the full range of motion of the handle bars for ease of rotation.
 - Overtightening will cause difficulty in turning the handle bars.
4. If the handle bars become difficult to turn, loosen the M10 Nut and retighten using a lower torque.

★ [IMG7020: LOCATION OF LOCK NUT, AND INDICATOR OF ROCKING DIRECTION]

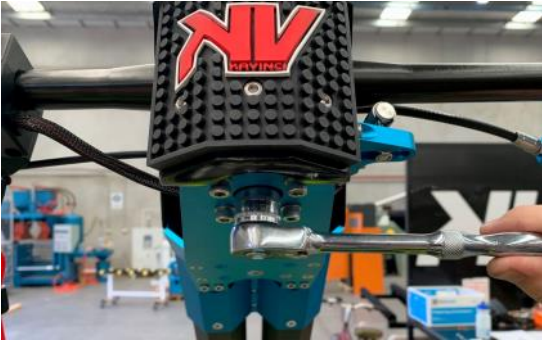

FOOTHOLD ADJUSTMENT (STANDUP'S ONLY)

The position of the footholds on the tray of the watercraft can be adjusted to suit the riders stance and riding style. The adjustment is best made ashore with the watercraft safely on the ground.

To reposition the footholds:

1. Loosen the two hex bolts on the foothold (13mm A/F) until the foothold can freely move.
2. With your riding footwear on, stand on the tray of the watercraft and slide your foot into the foothold.
 - Ensure the watercraft is suitably stable before standing on it
3. Adjust the foothold so it is firm around your footwear, but you can still easily remove your foot.

★ [IMG7030: FOOTHOLD NUT LOCATION WITH RIDER FOOT IN FOOTHOLD]



WARNING

DO NOT set the foothold overly tight around your foot. If you cannot remove your foot freely it could become stuck during operation and cause severe injury when falling off the watercraft, or when the ski becomes capsized.

4. Once the desired position has been selected, tighten both of the hex bolts on the foothold

STEERING CABLE ADJUSTMENT

The alignment of handlebars and the steering nozzle can be adjusted to ensure the watercraft travels straight ahead when the bars are straight ahead.

To adjust the position:

1. Lower the handle pole and position the handle bar to the straight ahead position.
2. Inspect the steering nozzle of the rear of the watercraft.
3. Compare the distance from the centre of steering nozzle to the left and right of the pump wall. The distances should be equal.

★ [IMG7040: PICTURE OF STEERING NOZZLE FROM REAR. SHOW LEFT AND RIGHT DISTANCE TO COMPARE]



4. If they are unequal, note whether A or B is greater.
5. Loosen the M5 Nut (8mm A/F) from the back of the cable holder at the pump end.
6. Remove the cable holder from the ball pivot by sliding back the retaining sleeve.
7. If the nozzle was pointing to the left ($B > A$) wind cable holder clockwise 1 - 2 turns onto threaded rod.
8. If the nozzle was pointing to the right ($A > B$) wind cable holder counter-clockwise 1 - 2 turns off threaded rod.
 - The cable holder must be screwed at least 8mm (0.315in) into the threaded rod.

★ [IMG7050: STEERING HOLDER MINIMUM ENGAGEMENT]

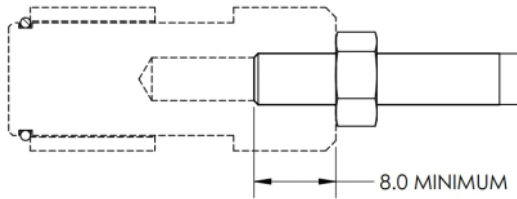

9. Insert the cable holder onto the ball pivot and re-check alignment. Repeat adjustment as necessary.
10. Once the alignment has been corrected, retighten the M5 Nut against the back of the cable holder.

THROTTLE CABLE ADJUSTMENT

The throttle cable position should be adjusted at the throttle lever to ensure the throttle returns to the correct idle position. The throttle lever should have some free play at the closed position.

★ [IMG7060: THROTTLE LEVER FREE PLAY]



Free play range is 3.0mm - 6.0mm (0.125in - 0.250in)

To adjust the free play:

1. Loosen the M6 Nut on the throttle cable (10mm A/F)
2. To increase free play, wind cable end further into lever
3. To decrease free play, wind cable end out of lever
4. Retighten M6 Nut once correct free play is set.

TRIM CABLE ADJUSTMENT

The trim cable position should be adjusted at the trim lever to ensure the cable is not pulling on the trim ring when in the closed position. The trim lever should have some free play in the closed position.

★ [IMG7070: TRIM LEVER FREE PLAY]



Free play range is 3.0mm - 6.0mm (0.125in - 0.250in)

To adjust the free play:

1. Loosen the M6 Nut on the trim cable (10mm A/F)
2. To increase free play, wind cable end further into lever
3. To decrease free play, wind cable end out of lever

- Retighten M6 Nut once correct free play is set.

IDLE SCREW ADJUSTMENT

The idle speed of the watercraft is set using the idle screw on the throttle body, near the throttle wheel. The idle should be set to achieve an idle speed of approximately 2200 RPM in the water. The idle screw is correctly set from the factory, however if adjustment becomes necessary follow the steps below.

To adjust the idle screw:

- While holding the M5 Socket Head Cap Screw using a 4mm Hex Bit or T-Bar, loosen the M5 Locknut (8mm A/F) a few turns.
- To increase idle speed, wind the M5 screw in (clockwise)
- To decrease idle speed, wind the M5 screw out (counter-clockwise)
- To set, while holding the M5 screw in position, tighten the M5 Locknut against the throttle body.

★ [IMG7080: IDLE SCREW LOCATION]

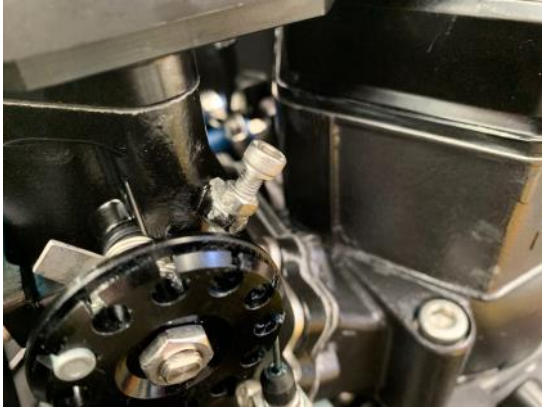

Periodic Maintenance Chart

The following chart lists the areas and items that must be inspected and the frequency for those inspections. An experienced watercraft mechanic should perform these inspections, and replace of parts that are worn or damaged. Kavinci Motors can provide technical documentation for most of the tasks upon request. Contact support@kavincimotors.com directly for more information.

★ [TABLE: PERIODIC MAINTENANCE CHART]

Description	Initial 10 Hrs	Every 25 Hrs	Every 100 Hrs OR 1 year
Check ALL hoses, clamps, nuts, bolts and fasteners	X	X	
Lubricate steering, throttle and trim cables		X	
Lubricate steering and trim pivot points		X	
Clean & Gap spark plugs (replace as needed)		X	
Inspect jet pump seals		X, then	X
Inspect engine output shaft seals		X, then	X
Inspect midshaft seals		X, then	X
Inspect Fuel pump & Filter		X	
Inspect Oil pump & Filter		X	
Inspect and clean flame arrestor screens		X	
Inspect fuel tank one-way & pressure relief valve		X	
Inspect oil tank one-way & pressure relief valve		X	
Inspect oil line check valves		X	
Inspect handle pole pivot bushings		X	
Inspect scupper outlet and bung		X	
Inspect and clean automatic bilge pump		X	
Inspect coupler rubber dampener			X
Inspect steering, throttle & trim cable			X
Replace Fuel Lines			X
Replace Oil Lines			X

Should we include something about checking the sacrificial anode in the maintenance chart?
 TB: Probably a good idea, not sure how often would be required. Would be good to avoid asking people to remove the Cyl. Head. I think we should include when pistons/cylinder bores need to be checked, or when the head comes off for some other check.

You are responsible for the maintenance and upkeep of your Krash Industries RTP watercraft. This is a high performance watercraft and as such, requires high maintenance. Neglecting the requirements, recommendations and/or warnings outlined in this owner's manual, as well as ignoring common sense and safety, can result in premature wear, damage and possible injury for which Krash Industries is not be responsible.

Troubleshooting Guide

If you are unable to determine the trouble contact your local Powersports dealer, repair centre, or Kavinci Motors directly at support@kavincimotors.com

[TABLE: TROUBLE TO CAUSE CHART]

